

SERVICE MANUAL

BA - 3 CHASSIS

<u>MODEL</u>	<u>COMMANDER</u>	<u>DEST.</u>	<u>CHASSIS NO.</u>	<u>MODEL</u>	<u>COMMANDER</u>	<u>DEST.</u>	<u>CHASSIS NO.</u>
KV-13M20	RM-Y116	CND	SCC-J93A-A	KV-14R20	RM-Y116	E	SCC-J94A-A
KV-13M20	RM-Y116	US	SCC-J84D-A	KV-14RD1	RM-Y116	E	SCC-J95A-A
KV-13M30	RM-Y116	US	SCC-J84A-A	KV-14PM1	RM-Y116	E	SCC-J95B-A
KV-13M31	RM-Y116	US	SCC-J84E-A				

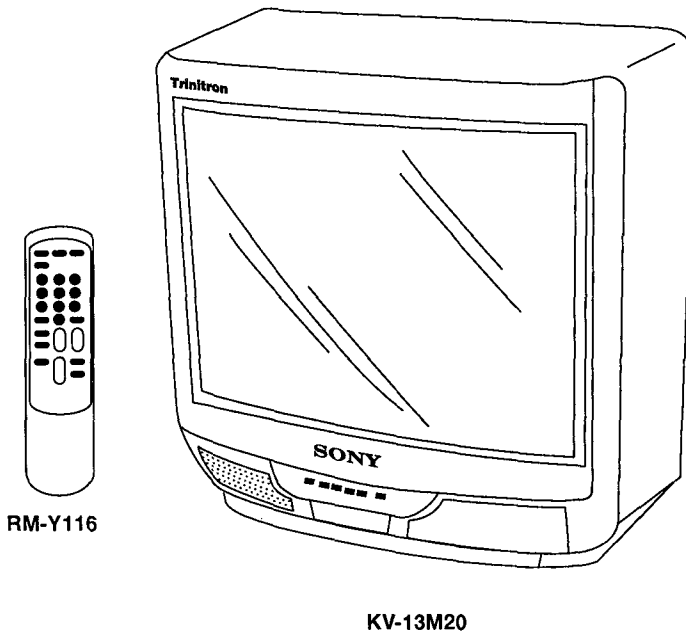

TRINITRON® COLOR TV
SONY®



※ Please file according to model size.

SPECIFICATIONS

■ KV-13M20/14R20/14RD1/14PM1/13M30/13M31

Television system	American TV standards
Channel coverage	VHF 2-13 UHF: 14-69 CATV: 1-125
Picture tube	Trinitron® tube 13-inch picture measured diagonally 14-inch picture measured diagonally
Antenna	75Ω external antenna terminal for VHF / UHF, F-Terminal
Input	VIDEO (phono jacks): 1Vp-p, 75Ω unbalanced negative sync Audio (phono jacks) 500 mVrms (100% modulation) Impedance: 47Ω A/V input (Rear) Front A/V input (KV-13M30/13M31 only)
Output	Headphone jack
Speaker output	1 speaker 2W(8Ω)
Speaker size	Full range 3 1/2 x 2 inches (90 x 50 mm)
Power requirements	120V AC, 60Hz
Power consumption	75W when in use 6W in standby
Dimensions (W/H/D)	14 1/8 x 13 1/2 x 15 3/4 in. (358 x 342 x 401.4 mm)
Weight	22 lbs.(10kg)
Supplied accessories	Remote Commander RM-Y116 (1) with 2 AA size (R6) battery Dipole antenna (1) Antenna connector (1)

Design and specifications are subject to change without notice.
SONY CORPORATION Printed in U.S.A.

SAFETY CHECK-OUT

(US model only)

After correcting the original service problem, perform the following safety checks before releasing the set to the customer:

1. Check the area of your repair for unsoldered or poorly-soldered connections. Check the entire board surface for solder splashes and bridges.
2. Check the interboard wiring to ensure that no wires are "pinched" or contact high-wattage resistors.
3. Check that all control knobs, shields, covers, ground straps, and mounting hardware have been replaced. Be absolutely certain that you have replaced all the insulators.
4. Look for unauthorized replacement parts, particularly transistors, that were installed during a previous repair. Point them out to the customer and recommend their replacement.
5. Look for parts which, through functioning, show obvious signs of deterioration. Point them out to the customer and recommend their replacement.
6. Check the line cords for cracks and abrasion. Recommend the replacement of any such line cord to the customer.
7. Check the condition of the monopole antenna (if any). Make sure the end is not broken off, and has the plastic cap on it. Point out the danger of impalement on a broken antenna to the customer, and recommend the antenna's replacement.
8. Check the B+ and HV to see they are at the values specified. Make sure your instruments are accurate, be suspicious of your HV meter if sets always have low HV.
9. Check the antenna terminals, metal trim, "metallized" knobs, screws, and all other exposed metal parts for AC leakage. Check leakage as described below.

LEAKAGE TEST

The AC leakage from any exposed metal part to earth ground and from all exposed metal parts to any exposed metal part having a return to chassis, must not exceed 0.5mA (500 microamperes) .

Leakage current can be measured by any one of three methods.

1. A commercial leakage tester, such as the Simpson 229 or RCA WT-540A. Follow the manufacturers' instructions to use these instruments.
2. A battery-operated AC milliammeter. The Data Precision 245 digital multimeter is suitable for this job.
3. Measuring the voltage drop across a resistor by means of a VOM or battery-operated AC voltmeter. The "limit" indication is 0.75V, so analog meters must have an accurate low-voltage scale. The Simpson 250 and Sanwa SH-63Trd are examples of a passive VOM that is suitable. Nearly all battery operated digital multimeters that have a 2V AC range are suitable. (See Fig. A)

HOW TO FIND A GOOD EARTH GROUND

A cold-water pipe is guaranteed earth ground; the cover-plate retaining screw on most AC outlet boxes is also at earth ground. If the retaining screw is to be used as your earth-ground, verify that it is at ground by measuring the resistance between it and a cold-water pipe with an ohmmeter. The reading should be zero ohms. If a cold-water pipe is not accessible, connect a 60-100 watts trouble light (not a neon lamp) between the hot side of the receptacle and the retaining screw. Try both slots, if necessary, to locate the hot side of the line, the lamp should light at normal brilliance if the screw is at ground potential. (See Fig. B)

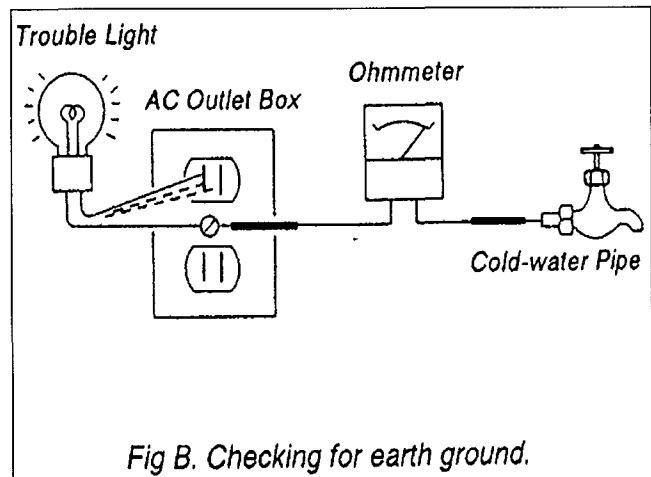
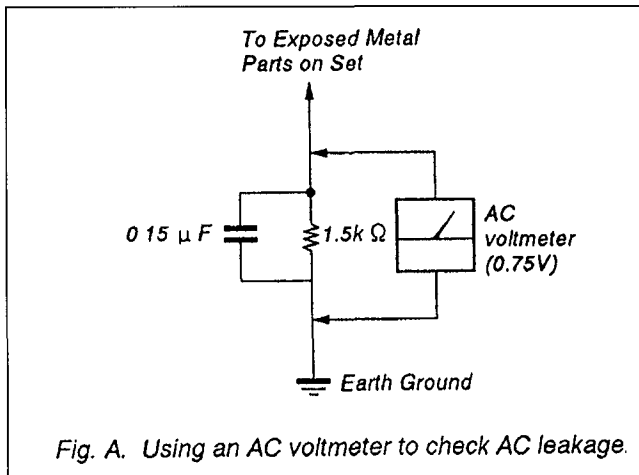

TABLE OF CONTENTS

<u>Section</u>	<u>Title</u>	<u>Page</u>	<u>Section</u>	<u>Title</u>	<u>Page</u>
1. GENERAL			4. SAFETY RELATED ADJUSTMENT		17
	Connecting the TV	5	5. CIRCUIT ADJUSTMENTS		
	Using the Remote Control	6	5-1. Electrical Adjustment by Remote Commander		19
	Setting Up Channels	6	5-2. A Board Adjustments		21
	Watching the TV	7	6. DIAGRAMS		
	Using the Video Menu	8	6-1. Block Diagrams		23
	Additional Features	9	6-2. Circuit Boards Location		27
	Selecting Caption Vision		6-3. Printed Wiring Boards and Schematic Diagrams		27
	Customizing the Channel Number Buttons		• A Board		
	Listening with Headphones		• C Board		
2. DISASSEMBLY			6-4. Semiconductors		36
2-1.	Rear Cover Removal	11	7. EXPLODED VIEWS		
2-2.	A Board Removal	11	7-1. Chassis		37
2-3.	Service Position	11	8. ELECTRICAL PARTS LIST		38
2-4.	Picture Tube Removal	12			
3. SET-UP ADJUSTMENTS					
3-1.	Beam Landing	13			
3-2.	Covergence	14			
3-3.	Focus	16			
3-4.	Screen (G2)	16			
3-5.	Method of Setting the Service Adjustment Mode	16			
3-6.	White Balance Adjustment	16			

(CAUTION)

SHORT CIRCUIT THE ANODE OF THE PICTURE TUBE AND THE ANODE CAP TO THE METAL CHASSIS, CRT SHIELD, OR CARBON PAINTED ON THE CRT, AFTER REMOVING THE ANODE

WARNING!!

AN ISOLATION TRANSFORMER SHOULD BE USED DURING ANY SERVICE TO AVOID POSSIBLE SHOCK HAZARD, BECAUSE OF LIVE CHASSIS.
THE CHASSIS OF THIS RECEIVER IS DIRECTLY CONNECTED TO THE AC POWER LINE.

SAFETY-RELATED COMPONENT WARNING!!

COMPONENTS IDENTIFIED BY SHADING AND MARK \triangle ON THE SCHEMATIC DIAGRAMS, EXPLODED VIEWS, AND IN THE PARTS LIST ARE CRITICAL TO SAFE OPERATION. REPLACE THESE COMPONENTS WITH SONY PARTS WHOSE PART NUMBERS APPEAR AS SHOWN IN THIS MANUAL OR IN SUPPLEMENTS PUBLISHED BY SONY. CIRCUIT ADJUSTMENTS THAT ARE CRITICAL TO SAFE OPERATION ARE IDENTIFIED IN THIS MANUAL. FOLLOW THESE PROCEDURES WHENEVER CRITICAL COMPONENTS ARE REPLACED OR IMPROPER OPERATION IS SUSPECTED.

SECTION 1 GENERAL

The operating instructions mentioned here are partial abstracts from the Operating Instruction Manual. The page numbers of the Operating Instructions remain as in the manual.

Step 1: Connecting the TV

You can use an indoor antenna, outdoor antenna, or cable system with your TV. Outdoor antennas or cable TV systems usually provide the best picture quality.

Connecting an Indoor, Outdoor or Cable Antenna

Connect your antenna or cable to the TV's VHF/UHF antenna terminal

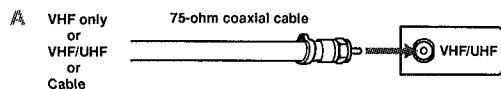

If you cannot connect your antenna or cable directly to the TV antenna terminal, follow one of the diagrams below

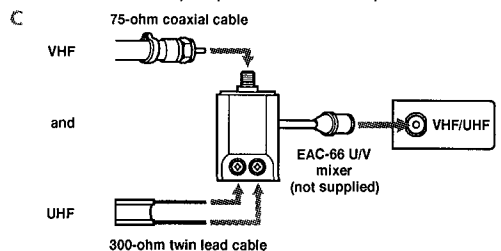
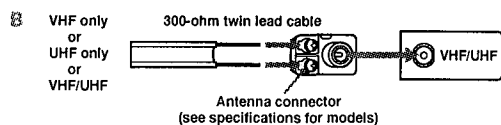

Connecting to a Cable TV System Through a Cable Box

If your cable system requires use of a cable box, make the connection as shown below.

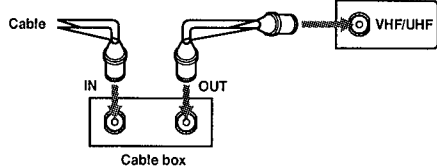

Connecting a VCR

See your VCR instructions to set up the VCR. After connecting the VCR to the TV, you will be able to do the following:

- Watch video tapes
- Record one TV program while viewing another

Check the model number of your TV and select the appropriate connection diagram

Notes

- If your cable system requires use of a Cable Box, install it between the VCR and the TV.
- For a monaural VCR, connect the audio output of the VCR to AUDIO L (MONO) on the TV
- Connect your S-Video cable (KV-20V60 only) to the S-Video input on the TV. S-Video will override your standard video input, providing the most stable picture

3

Warnings and Cautions • Connecting the TV • Connecting an Antenna • Connecting a Cable Box • Connecting a VCR

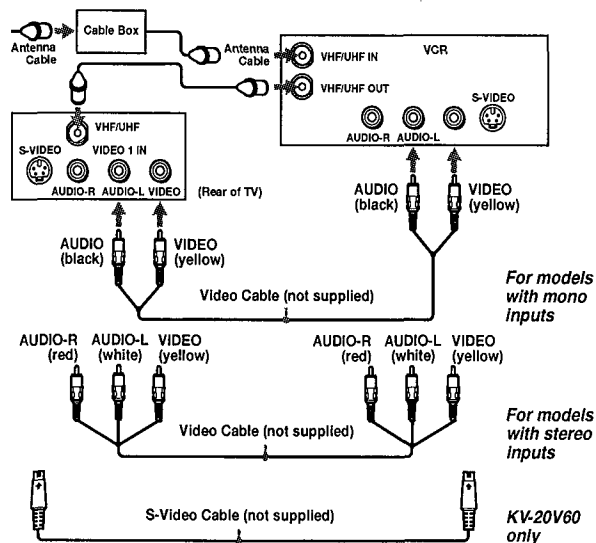

Connecting a Camcorder

KV-13M30, 13M31, 20S30, 21RS30C only

Use this connection to view a video tape from a camcorder.

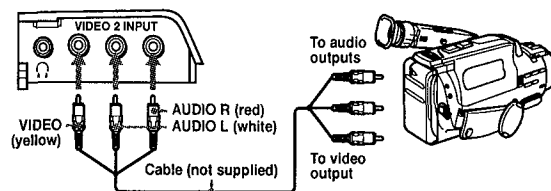

Notes

- For a monaural camcorder, connect the audio output of the camcorder to AUDIO L (MONO) on the TV
- If you are connecting your camcorder to a monaural TV (KV-13M30, 13M31 only), plug the audio connector into the AUDIO input on the TV
- You can also connect a camcorder to inputs on the rear of the TV

Connecting an Audio System

KV-20S30, 21RS30C only

To listen to TV audio through a separate stereo system, connect the TV as shown below. See page 11 to switch to the external speakers.

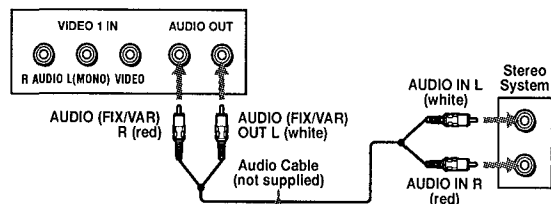

4

Step 2: Using the Remote Control

Instructions in this manual are based on using the remote control. You can also use the controls on the TV.

The menu illustrations are from KV-20M20. When features found on other models are discussed, the manual lists the models covered by that specific set of menus.

Note

- The menu disappears 90 seconds after you press a button, or immediately after you press **MENU**.

Inserting Batteries

Insert two size AA (R6) batteries (supplied) by matching the + and - on the batteries to the + and - inside the battery compartment. With normal use, the batteries should last for approximately six months.

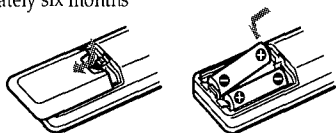

Notes

- Remove the batteries to avoid possible damage from battery leakage if you will not be using the remote control for an extended period of time.
- Handle the remote control with care. Avoid dropping it, getting it wet, or placing it in direct sunlight, near a heater, or where the humidity is high.

Changing the Menu Language

Except Canadian models

If you want to view the menus in Spanish, you can change the menu language.

- 1 Press **MENU**. The Main menu appears.



- 2 Press **Δ+** or **∇-** to move the cursor (▶) to **ENGLISH** and press **RETURN**.

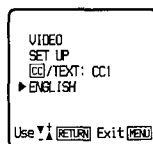
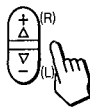

ENGLISH will turn red.

- 3 Press **Δ+** or **∇-** to select **ESPAÑOL** and press **RETURN**.

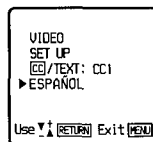
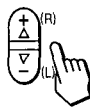

ESPAÑOL will turn green.

- 4 Press **MENU** to return to the TV program.

Note

- Some parts of the Spanish menus will appear in English.

5

Step 3: Setting up Your Channels

Setting Cable TV On or Off

If you have connected the TV to a cable TV system, set **CABLE** to **ON**. If not, set **CABLE** to **OFF**.

- 1 Press **MENU**.
- 2 Move the cursor to **SET UP** and press **RETURN**.
- 3 Move the cursor to **CABLE** and press **RETURN**.

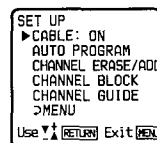

- 4 Press **Δ+** or **∇-** to select **ON** or **OFF**.
- 5 Press **RETURN**.
- 6 Press **MENU** to return to the TV program.

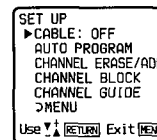

Note

- If the screen is black, the TV is set to a video input and you cannot select **CABLE**. Press **TV/VIDEO** until a channel number appears, then follow steps 1-6.

Auto Programming Your Channels

TV channels can be preset easily. First, you can store all the receivable channels automatically. Later, you can erase unwanted channels or add additional channels.

Notes

- If the TV is set to **VIDEO**, you cannot run **AUTO PROGRAM**. Press **TV/VIDEO** on the remote control until a channel number appears.
- It is usually best to preset channels during the day when the greater number of channels are broadcasting.

- 1 Press **MENU**. The Main menu appears.

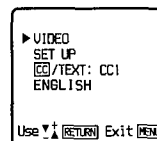

- 2 Press **Δ+** or **∇-** on the remote control to move the cursor (▶) to **SET UP**. Press **RETURN**.

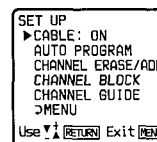
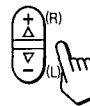

The **SET UP** menu appears.

- 3 Press **Δ+** or **∇-** to move the cursor to **AUTO PROGRAM** and press **RETURN**.

AUTO PROGRAM appears on the screen and the TV starts scanning and presetting channels.

When all of the receivable channels are stored, **AUTO PROGRAM** disappears.

Note

- AUTO PROGRAM** will tune in all of the channels in your area, including some with weak or scrambled signals. They will appear fuzzy on the screen. You can erase them using **CHANNEL ERASE/ADD**.

6

Erasing or Adding Channels

After you run AUTO PROGRAM, you can erase unnecessary channels or add new ones.

- 1 Press **MENU**.
- 2 Press **Δ+** or **∇-** to select **SET UP** and press **RETURN**.
- 3 Press **Δ+** or **∇-** to select **CHANNEL ERASE/ADD** and press **RETURN**.

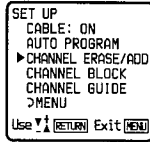
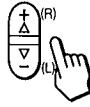

- 4 To erase or add an unwanted channel:

- (1) Press **CH +/-** or **0-9** to select the channel you want to erase or add.
- (2) Press **Δ+** or **∇-** to select **ERASE** or **ADD**.
- (3) Press **RETURN**

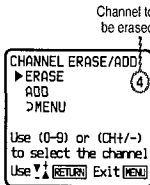

If you are erasing a channel, the “-” symbol appears next to the channel number. If you are adding a channel, the “+” symbol appears next to the channel number.

- 5 To erase or add other channels, repeat step 4.
- 6 Press **MENU** to return to the TV program.

Note

- If you erase or add a VHF or UHF channel, the cable TV channel with the same number is also erased or added

Watching the TV

Press **POWER** to turn the TV on.

Note

- If **VIDEO** appears on the screen, press **TV/VIDEO** so that a channel number appears

Selecting a Channel Directly

Press **0-9** to select a channel.

The channel will change after 2 seconds, or you can press **ENTER** for immediate selection

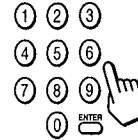

Scanning Through Channels

Press **CH +/-** until the channel you want appears.



Jumping Quickly Between Two Channels

Press **JUMP**.

The TV switches from the current channel to the previous channel that you watched.

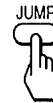

Pressing **JUMP** again switches back to the first channel.

Note

- You can only jump to channels you have selected with the 0-9 keys, or back to the last channel you scanned

Adjusting the Volume

Press **VOL +/-** to adjust the volume.



Muting the Sound

Press **MUTING**.

MUTING appears on the screen

To restore the sound, press **MUTING** again, or press **VOL +**



Displaying On-Screen Information

Use the DISPLAY key to check the TV's Display settings

1 Press DISPLAY.

The channel number will be displayed. The TV will also display the MTS mode if SAP, MAIN, or MONO are selected (except KV-13M20, 13M30, 20M20) The MTS mode display disappears after 4 seconds



2 Press DISPLAY again.

XDS ON will appear on the screen. If XDS (Extended Data Service) is broadcasting, information will then appear on the screen (except KV-13M20, 14PM1, 14R20, 14R20C, 14RD1)

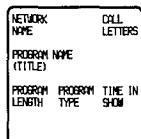

3 Press DISPLAY again.

CC1 ON (if selected) will appear on the screen for a few seconds. Captions will then appear at the top or bottom of the screen.

4 To turn off Caption Vision or XDS display, press DISPLAY again until DISPLAY OFF appears.

Note

- See page 13 for more information about Caption Vision

Watching Video Tapes

1 Press TV/VIDEO until the correct video input appears.



2 Press PLAY on your VCR to view the video tape.

Setting the Sleep Timer

Sleep Timer allows the TV to stay on for a length of time and then shut off automatically

1 Press SLEEP until the time you want appears.

Each time you press SLEEP, the display moves between 30, 60, 90, and OFF

In a few seconds, the SLEEP message disappears.

TV WILL BE OFF SOON appears one minute before the TV shuts off

2 To cancel the Sleep Timer, press SLEEP again until SLEEP OFF appears, or turn off the TV.

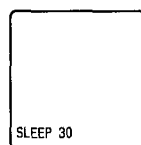

Using the VIDEO Menu

Adjusting the Video Settings

You can adjust the picture, hue, color, brightness, and sharpness of any TV image.

1 Press MENU.

2 Move the cursor (►) to VIDEO and press RETURN.



3 Press Δ+ or ▽- to select the feature that you want to adjust and press RETURN.

See the Adjustable Items chart for a list of the adjustments you can make



4 Press Δ+ or ▽- to adjust the setting of the selected feature and press RETURN.

The new setting appears in the VIDEO menu



5 To adjust other video settings, repeat steps 3 and 4.

6 Press MENU to return to the TV program.

ADJUSTABLE ITEMS

Item	Press Δ+ (R) to	Press ▽- (L) to
PICTURE	Increase the contrast	Decrease the contrast
HUE	Increase the green tones	Decrease the green tones
COLOR	Increase color intensity	Decrease color intensity
BRIGHTNESS	Brighten the picture	Darken the picture
SHARPNESS	Sharpen the picture	Soften the picture

Restoring the Factory Video Settings

1 To restore the factory video settings, press RESET while the VIDEO menu is displayed.

All the settings except PICTURE are restored to factory settings

Watching the TV • Selecting a Channel • Scanning • Jumping • Volume • Muting • On-Screen Information • Watching Video Tapes • Sleep Timer

Using the VIDEO Menu • Adjusting the Video Settings

Additional Features

Selecting Stereo or Bilingual Programs (MTS)

KV-20S20, 20S21, 20S30, 20V60, 21PS1, 21RS20, 21RS20C, 21RS30C, 21SD1 only. Menus shown are for KV-20S20.

The Multichannel TV Sound (MTS) feature allows you to enjoy stereo sound (MAIN), Second Audio Programs (SAP), or monaural sound (MONO) when available.

- 1 Press MENU.
- 2 Move the cursor to AUDIO and press RETURN.
- 3 Move the cursor to MTS and press RETURN.
- 4 Press Δ + or ∇ - to select MAIN, SAP, or MONO.
- 5 Press MENU to return to the TV program.

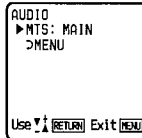
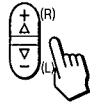

Choose	To
MAIN	Listen to stereo sound
SAP	Listen to bilingual and other programs
MONO	Reduce noise during poor stereo broadcasts.

Note

- The sound of non-SAP programs will be muted when SAP is selected. If there is no SAP audio, you may hear unrelated audio in English.

Setting the Speaker Switch (SPEAKER)

KV-20S30, 20V60, 21RS30C only.

You may switch off the TV speakers when you want to listen to the TV sound through a separate stereo system.

- 1 Press MENU.
- 2 Move the cursor to AUDIO and press RETURN.
- 3 Move the cursor to SPEAKER and press RETURN.
- 4 Press Δ + or ∇ - to select ON or OFF.
- 5 Press MENU to return to the TV program.



Choose	To
ON	Listen to the sound from the TV
OFF	Turn off the TV speaker and listen to the TV's sound through external audio system speakers

Changing Audio Out Speaker Volume

KV-20S30, 20V60, 21RS30C only.

You can control the volume of the TV program when you play the TV sound through a separate stereo system.

- 1 Press MENU.
- 2 Move the cursor to AUDIO and press RETURN.
- 3 Move the cursor to SPEAKER and press RETURN.
- 4 Press Δ + or ∇ - to set SPEAKER to OFF. Press RETURN.

- 5 Move the cursor to FIXED or VARIABLE and press RETURN. Your selection will turn yellow.
- 6 Press MENU to return to the TV program.

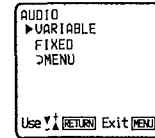

Choose	To
FIXED	Adjust the volume with your stereo
VARIABLE	Adjust the volume through the TV

Note

- Set the volume on your stereo low when switching from VAR to FIXED to avoid overloading your speakers.

Turning on Surround Sound

KV-20V60 only

Use this feature to listen to TV audio in Surround Sound mode.

- 1 Press MENU.
- 2 Move the cursor (\blacktriangleright) to AUDIO and press RETURN.
- 3 Move the cursor to SURROUND and press RETURN.
- 4 Press Δ + or ∇ - to set Surround ON or OFF.
- 5 Press MENU to return to the TV program.



Adjusting Treble, Bass, and Balance

KV-20V60 only

- 1 Press MENU.
- 2 Move the cursor (\blacktriangleright) to AUDIO and press RETURN.
- 3 Move the cursor to TREBLE, BASS, or BALANCE and press RETURN.



Choose	To
TREBLE	Increase or decrease high pitch sounds
BASS	Increase or decrease low pitch sounds
BALANCE	Change the balance between speakers

- 4 Press Δ + or ∇ - to increase or decrease the setting.
- 5 Press RETURN to make other audio adjustments.
- 6 Press MENU to return to the TV program.

Restoring the Factory Audio Settings

- 1 To restore the factory audio settings, press RESET while the AUDIO menu is displayed.

Blocking Out a Channel (CHANNEL BLOCK)

This feature allows you to prevent children from watching selected channels.

- 1 Press MENU.
- 2 Move the cursor to SET UP and press RETURN.
- 3 Move the cursor to CHANNEL BLOCK and press RETURN.

- 4 Move the cursor to 1 or 2 and press RETURN.

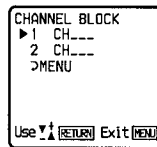

- 5 Press Δ+ or ▽- to select the channel that you want to block. Press RETURN.

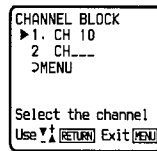

- 6 Repeat steps 4 and 5 to enter the second channel that you want to block.
- 7 Press MENU to return to the TV program.

If you switch to the blocked channel, BLOCKED appears. The screen is black and the sound is muted.

To cancel a CHANNEL BLOCK setting

- Follow steps 1–4 above.
- Press RESET.

Selecting a Caption Vision Option

Caption Vision options include CC1, 2, 3, and 4, or TEXT1, 2, 3, and 4. CC1, 2, 3, and 4 show a caption or printed version of the dialog or sound effects of a program. CC1 will be the setting for most programs. TEXT1, 2, 3, and 4 show text information on half of the screen. This text is not usually related to the program.

- Press MENU.
- Press Δ+ or ▽- to select [CC/TEXT: CC1] and press RETURN.

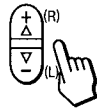

- Press Δ+ or ▽- to select the caption type (CC1, 2, 3, 4, or TEXT1, 2, 3, or 4) and press RETURN.
- Press MENU to return to the TV program.
- To view Caption Vision, press DISPLAY several times until CC1, 2, 3, 4, or TEXT1, 2, 3, 4 ON is displayed if broadcasting. The caption will appear in a few seconds.
- To turn off Caption Vision, press DISPLAY until DISPLAY OFF appears.

Notes

- Captions disappear for a few seconds when you press the MUTING button.
- Captions may appear with a white box or other errors if you have poor reception of the channel.

Customizing the Channel Number Buttons (CHANNEL GUIDE)

You can assign up to 12 of your favorite channels to Channel Guide locations and switch to them with the Channel Guide.

- Press MENU.
- Press Δ+ or ▽- to select SET UP and press RETURN.
- Press Δ+ or ▽- to select CHANNEL GUIDE and press RETURN.

- 4 Press RETURN again to move the cursor to the number pad.

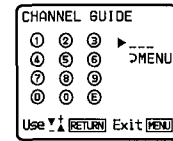

- 5 Press Δ+ or ▽- to select a number on the Channel Guide (the button number will turn red) and press RETURN.

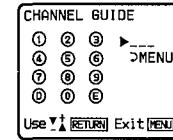

The ___ turns red.
Buttons 0–9, DISPLAY (D) and ENTER (E) are available for Channel Guide access.

- 6 Press Δ+ or ▽- to select the channel that you want to assign to that button, and press RETURN.

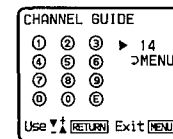

The TV will switch to that channel.

- Repeat steps 5–7 to set other channels.
- Press MENU to return to the current TV program.

To remove a CHANNEL GUIDE setting

- Repeat steps 1–6 to select the channel that you want to remove.
- Press RESET.

Using the Channel Guide

- Press CH GUIDE.

The Channel Guide shows button numbers and the channels assigned to them.

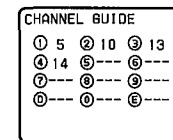

- Press 0–9, DISPLAY or ENTER on the remote control to switch to the channel you want to view.
- To cancel the CHANNEL GUIDE display without selecting a channel, press CH GUIDE again.

Listening with Headphones or an Earphone

Plug the headphones or earphone into the jack on the front of the TV. Using headphones will turn off the sound to the TV speakers. KV-13M20 is shown below.

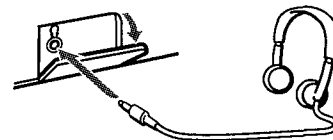

Notes

- To prevent hearing damage due to sudden or prolonged excessive volume, do not set the volume too high while listening.
- If your TV is monaural, the monaural sound will be heard from both headphones.

SECTION 2 DISASSEMBLY

2-1. REAR COVER REMOVAL

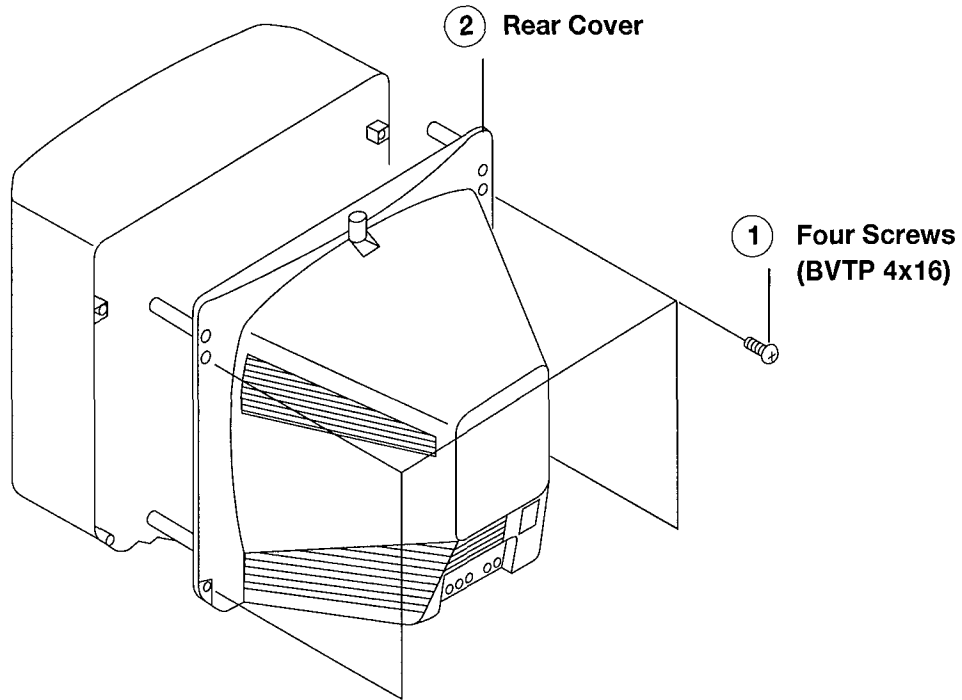

2-2. A BOARD REMOVAL

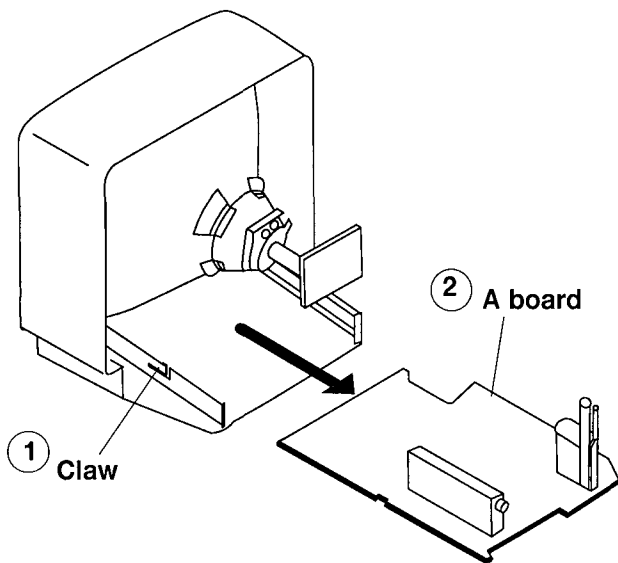

2-3. SERVICE POSITION

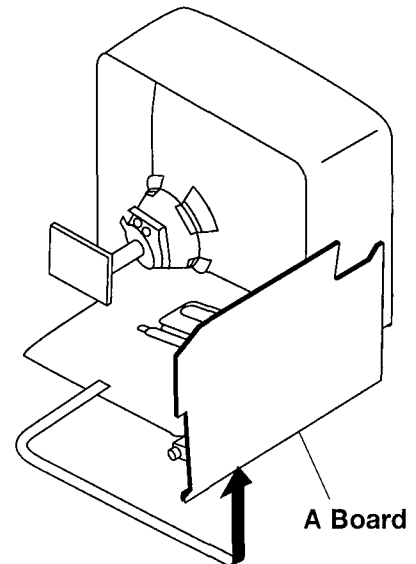

WARNING Before removing anode cap:

H.V. remains in the CRT even after the power is disconnected.

To avoid electrical shock before attempting to remove the anode cap, discharge CRT by shorting between anode and CRT mounting bracket.

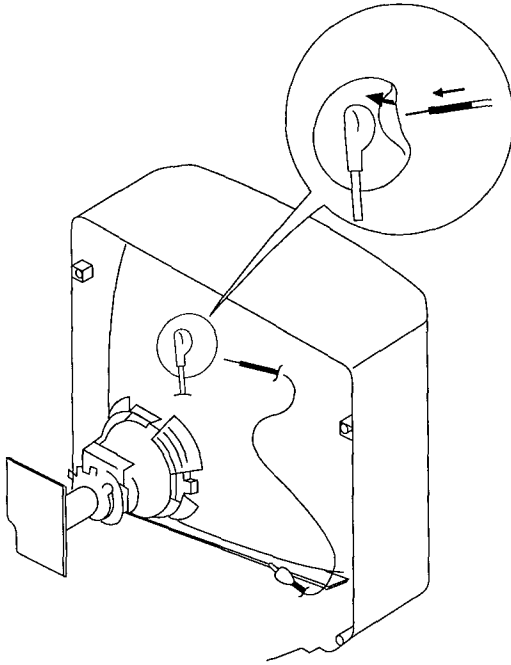

2-4. PICTURE TUBE REMOVAL

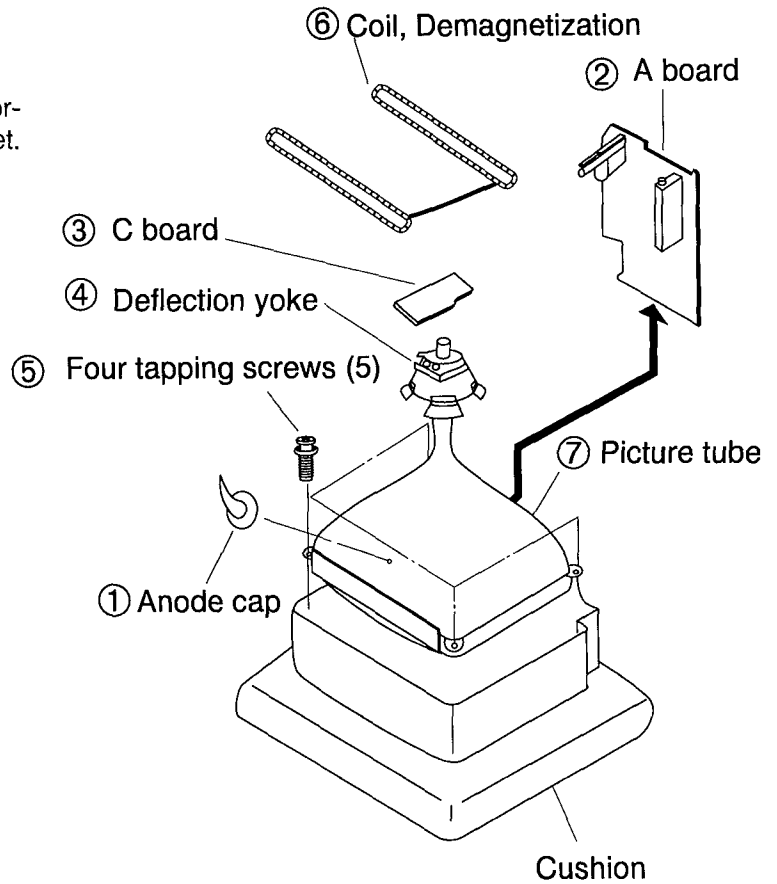

• REMOVAL OF ANODE-CAP

NOTE: Short circuit the anode of the picture tube and the anode cap to the metal chassis, CRT shield or carbon painted on the CRT after removing the anode.

• REMOVING PROCEDURES

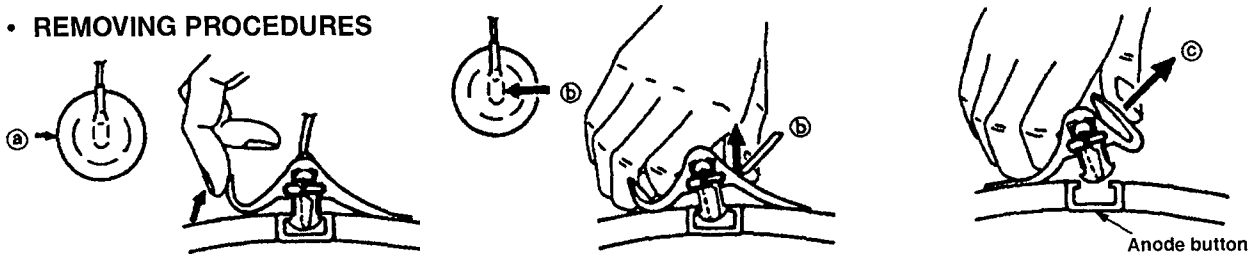

- ① Turn up one side of the rubber cap in the direction indicated by the arrow ①.
- ② Using a thumb pull up the rubber cap firmly in the direction indicated by the arrow ②.
- ③ When one side of the rubber cap is separated from the anode button, the anode-cap can be removed by turning up the rubber cap and pulling it up in the direction of the arrow ③.

• HOW TO HANDLE AN ANODE-CAP

- ① Don't damage the surface of anode-caps with sharp shaped material!
- ② Don't press the rubber so as not to damage the inside of anode-caps. A material fitting called a shatter-hook terminal is built into the rubber cap.
- ③ Don't turn over the foot of rubber cap. The shatter-hook terminal will stick out or damage the rubber cap.

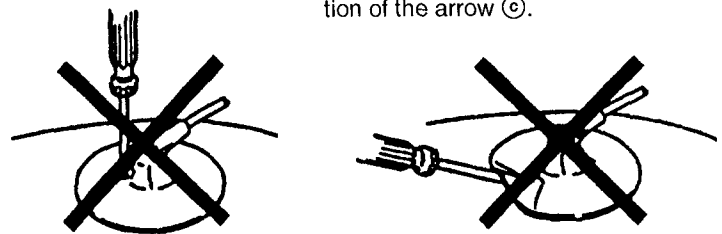

SECTION 3 SET-UP ADJUSTMENTS

- The following adjustments should be made when a complete realignment is required or a new picture tube is installed.
- These adjustments should be performed with rated power supply voltage unless otherwise noted.

The controls and switch should be set as follows unless otherwise noted:

PICTURE control normal

BRIGHTNESS control normal

Preparation:

- Feed in the white pattern signal.
- Before starting, degauss the entire screen.

3-1. BEAM LANDING

1. Input a raster signal with the pattern generator.
2. Loosen the deflection yoke mounting screw, and set the purity control to the center as shown in Fig.2.
3. Turn the raster signal of the pattern generator to green.
4. Move the deflection yoke backward, and adjust with the purity control so that green is in the center and red and blue are at the sides evenly. (Fig.3)
5. Move the deflection yoke forward, and adjust so that the entire screen becomes green. (Fig.1)
6. Switch over the raster signal to red and blue and confirm the condition.
7. When the position of the deflection yoke is determined, tighten it with the deflection yoke mounting screw.
8. When landing at the corner is not right, adjust by using the disk magnets. (Fig.4)

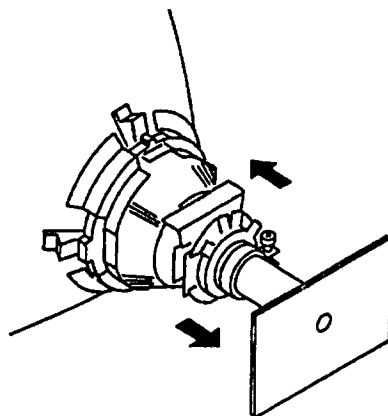

Fig. 1

Perform the adjustments in order as follows:

1. Beam Landing
2. Convergence
3. Focus
4. Screen (G2) and White Balance

Note: Test Equipment Required

1. Color Bar Pattern Generator
2. Degausser
3. DC Power Supply
4. Digital Multimeter

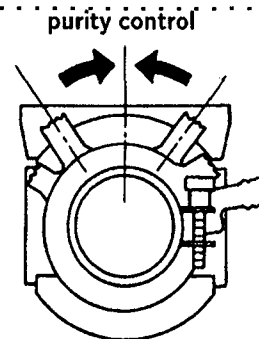

Fig. 2

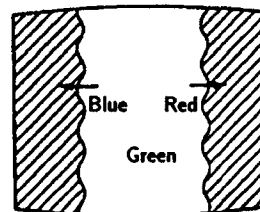

Fig. 3

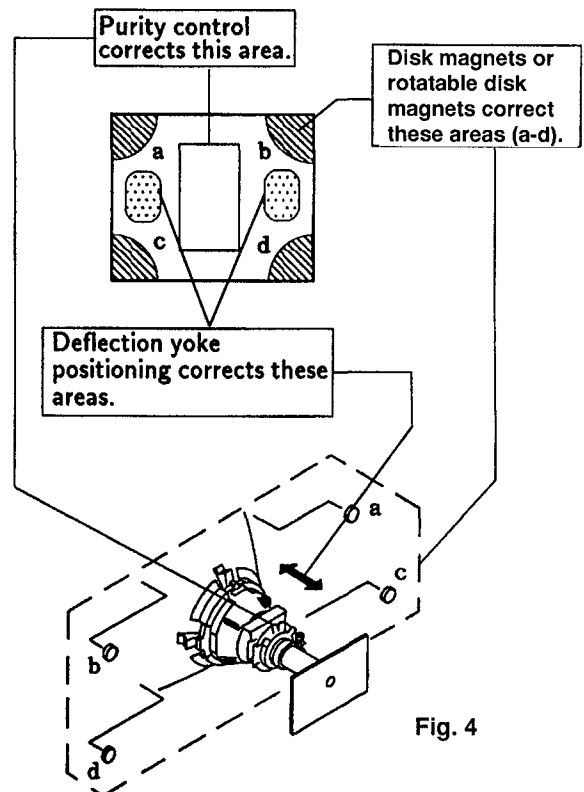

Fig. 4

3-2. CONVERGENCE

Preparation:

- Before starting, perform FOCUS, V. LIN and V. SIZE adjustments.
- Set BRIGHTNESS control to minimum.
- Feed in dot pattern.

(1) Vertical Static Convergence

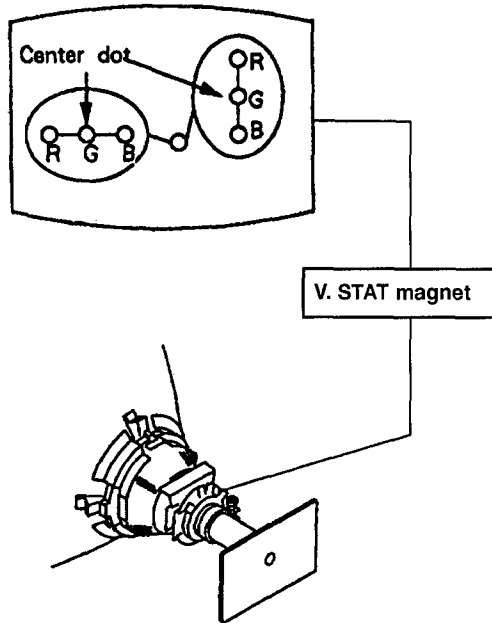
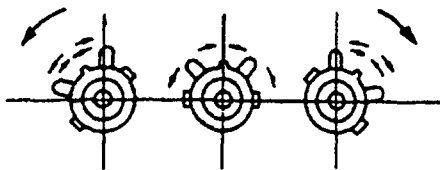
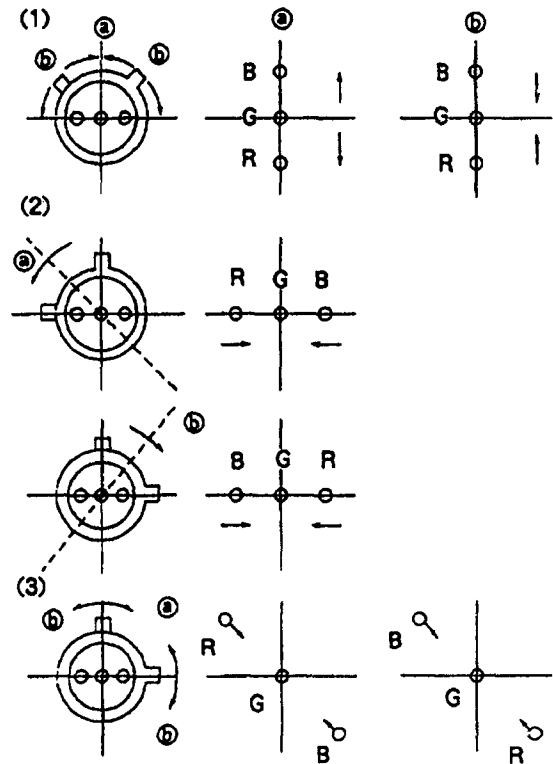

Fig. 5

1. Adjust V. STAT magnet to converge red, green and blue dots in the center of the screen. (Vertical movement)
- Tilt the V. STAT magnet and adjust static convergence to open or close the V. STAT magnet.



2. When the V. STAT magnet is moved in the direction of arrow (a) and (b), red, green, and blue dots move as shown below.



If the blue dot does not converge with red and green dots, perform the following steps:

Move BMC magnet (a) to correct insufficient H. Static convergence.

Rotate BMC magnet (b) to correct insufficient V. Static convergence.

In either case, repeat Beam Landing Adjustment.

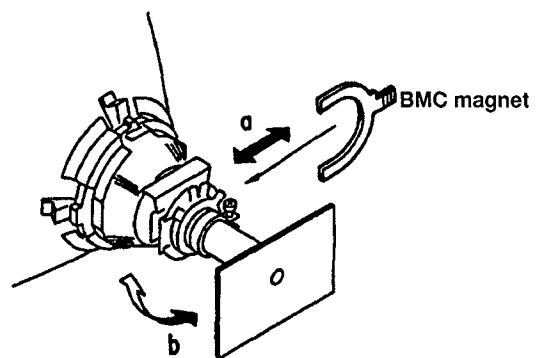

Fig. 6

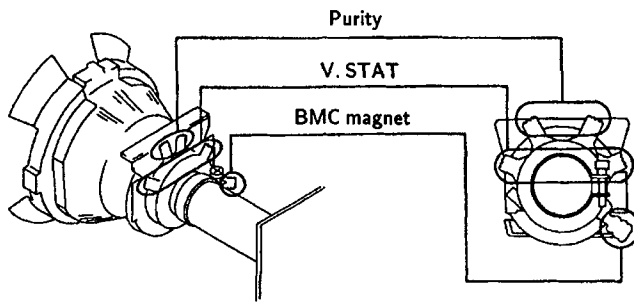

Fig. 7

(2) Dynamic Convergence Adjustment

Preparation:

- Before starting to perform Horizontal and Vertical Static Convergence Adjustment.
1. Slightly loosen deflection yoke screw.
 2. Remove deflection yoke spacers.
 3. Move the deflection yoke for best convergence as shown below.
 4. Tighten the deflection yoke screw.
 5. Install the deflection yoke spacers.

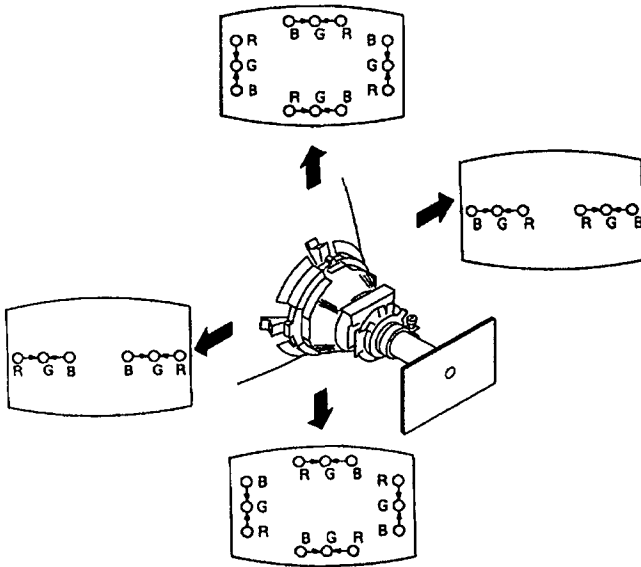

Fig. 8

(3) Screen-corner Convergence

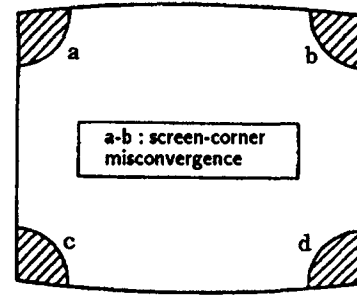
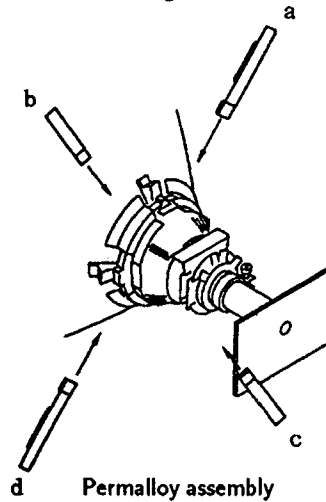

Fig. 9



Affix a Permalloy ass'y corresponding to the misconverged areas



3-3. FOCUS

Adjust FOCUS (RV703) control for best picture.

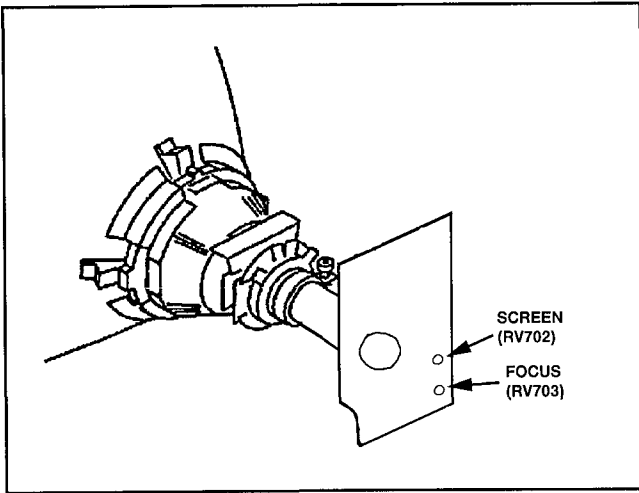

Fig. 10

3-4. SCREEN (G2)

1. Input a dots pattern.
2. Set the PICTURE and BRIGHT controls at minimum and COLOR controls at normal.
3. Adjust SBRT, GCUT, BCUT in service mode so that voltages on the red, green and blue cathodes are 160 Vdc with an oscilloscope as shown in Fig.11.
4. Observe the screen and adjust SCREEN (G2 RV 702) to obtain the faintly visible background of dot signal.

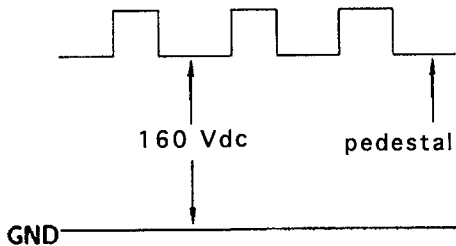

Fig. 11

3-5. METHOD OF SETTING THE SERVICE ADJUSTMENT MODE

SERVICE MODE PROCEDURE

1. Standby mode. (Power off)
2. **DISPLAY** → **5** → **VOL(+)** → **POWER** on the Remote Commander. (Press each button within a second.)

SERVICE ADJUSTMENT MODE IN

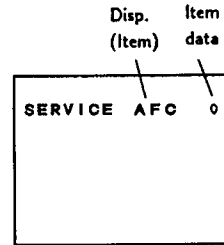

3. The CRT displays the item being adjusted.
4. Press **1** or **4** on the Remote Commander to select the item.
5. Press **3** or **6** on the Remote Commander to change the data.
6. Press **MUTING** then **ENTER** to write into memory.

SERVICE ADJUSTMENT MODE MEMORY

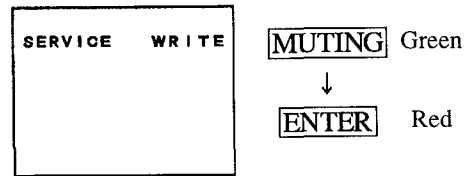

7. Turn set off and on to exit.

3-6. WHITE BALANCE ADJUSTMENTS

1. Input an entire white signal.
2. Set to Service adjustment Mode.
3. Set the PICTURE and BRIGHT to minimum.
4. Adjust with SBRT if necessary.
5. Select GCUT and BCUT with **1** and **4**.
6. Adjust with **3** and **6** for the best white balance.
7. Set the PICTURE and BRIGHT to maximum.
8. Select GDRV and BDRV with **1** and **4**.
9. Adjust with **3** and **6** for the best white balance.
10. Write into the memory by pressing **MUTING** then **ENTER**.

SECTION 4 SAFETY RELATED ADJUSTMENTS

A BOARD

☒ R525 CONFIRMATION METHOD (HV HOLD-DOWN CONFIRMATION) AND READJUSTMENTS

The following adjustments should always be performed when replacing the following components (marked with ☒ on the schematic diagram).

IC301, IC502, IC601, D505, D506, D507, D510, DY, C503, C511, C513, C528, R511, R519, R520, R523, R525, R527, R559, R560, R617, R618, R652, R653, R654, T504 (FBT)

1. PREPARATION BEFORE CONFIRMATION

- 1) Turn the POWER switch ON. Input an entirely white signal and set the PICTURE and BRIGHT controls to maximum.
- 2) Confirm that the voltage at TP-85 is more than 90VDC when the set is operating normally with 120.0 ± 2.0 VAC supply.

2. HOLD-DOWN OPERATION CONFIRMATION

- 1) Connect the current meter between Pin 11 of the FBT (T504) and the PCB land where Pin 11 would normally attach.
- 2) Input a white signal and adjust the ABL current to be $1040 \pm 100\mu\text{A}$ using the PICTURE and the BRIGHT controls.
- 3) Confirm the voltage of A board TP-91 is $113.4 \pm 0.3\text{VDC}$.
- 4) Connect the Digital Voltmeter and DC power supply via 1SS119 to TP-85.
- 5) Increase the DC power voltage gradually until the picture blanks out.
- 6) Read the digital voltmeter indication.
- 7) Turn DC power source off immediately.

STANDARD

Less than or equal to 117.75 VDC

- 8) Input a dot signal and adjust the ABL current to be $40+100/-40\mu\text{A}$ using the PICTURE and the BRIGHT controls.
- 9) Confirm the voltage of A board TP-91 is $116.4 \pm 0.3\text{VDC}$.
- 10) Repeat steps from (4) to (7).

STANDARD

Less than or equal to 117.75 VDC

3. HOLD-DOWN READJUSTMENT

If the current setting indicated in step 2-2 cannot be met, readjustment should be performed by altering the resistance value of R525 (a component marked with ☒).

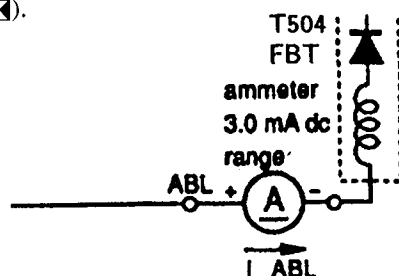

B+ VOLTAGE CONFIRMATION AND ADJUSTMENT

The following adjustments should always be performed when replacing the following components. (marked with ☒ on the schematic diagram).

IC001, IC601, R030, R617, R618, R629, R630, R651, R652, R653, R654, R655, R656

- 1) Supply 130 ± 2^0 V AC to the set with a variable auto transformer.
- 2) Input a dot signal.
- 3) Set the PICTURE control and the BRIGHT control to minimum condition.
- 4) Set to Service adjustment Mode.
- 5) Select PADJ with [1] and [4].
- 6) Adjust with [6] to the 0 level.
- 7) Confirm the voltage of A BOARD TP-91 is less than 123.0V DC.
- 8) If step 7 is not satisfied, replace the components, repeat the above steps.
- 9) Supply 120.0 ± 2.0 VAC to the set with a variable auto transformer.
- 10) Adjust with [3] and [6] for the 116.4 ± 0.3 VDC.
- 11) Write into the memory by pressing **MUTING** then **ENTER**.

DIGITAL MULTIMETER

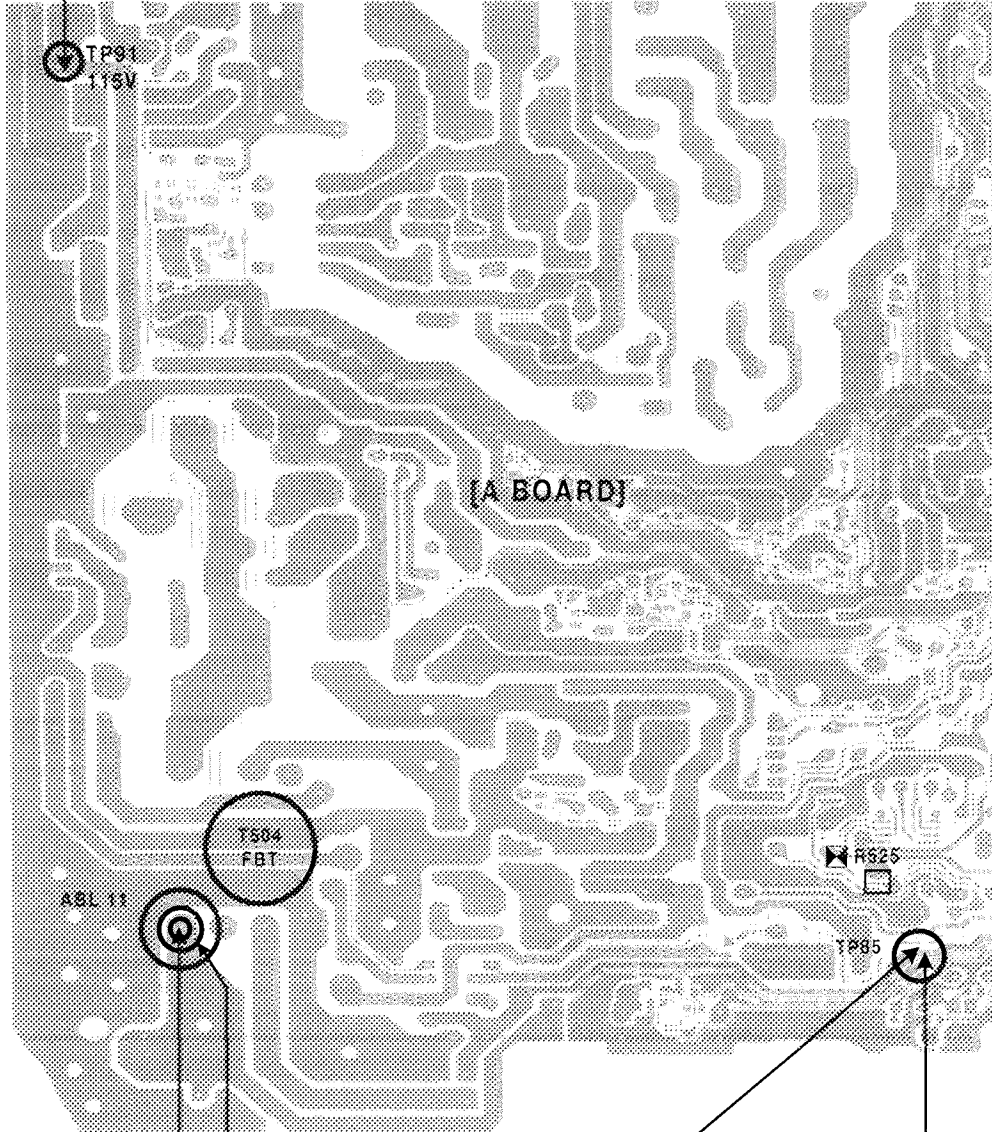
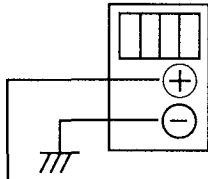

AMMETER
3mA dc range

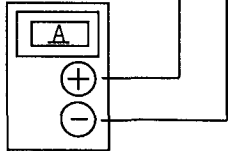

POWER SUPPLY

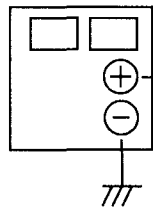

1SS119

DIGITAL
MULTIMETER

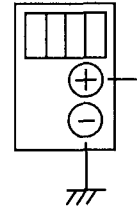

SECTION 5 CIRCUIT ADJUSTMENTS

5-1. ELECTRICAL ADJUSTMENT BY REMOTE COMMANDER

Use Remote Commander (RM-Y116) to perform circuit adjustments on this model.

NOTE : Test Equipment Required.

1. Pattern Generator
2. Frequency Counter
3. Digital Multimeter
4. Audio OSC

1. METHOD OF SETTING THE SERVICE ADJUSTMENT MODE

SERVICE MODE PROCEDURE

1. Standby mode. (Power off)
2. **DISPLAY** → **5** → **VOL (+)** → **POWER** on the Remote Commander. (Press each button within a second.)

SERVICE ADJUSTMENT MODE IN

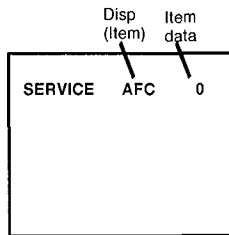

3. The CRT displays the item being adjusted.
4. Press **1** or **4** on the Remote Commander to select the item.
5. Press **3** or **6** on the Remote Commander to change the data.
6. Press **MUTING** then **ENTER** to write into memory.

SERVICE ADJUSTMENT MODE MEMORY

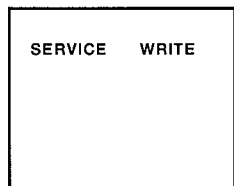

MUTING Green
↓
ENTER Red

7. Press **8** then **ENTER** on the Remote Commander to initialize.

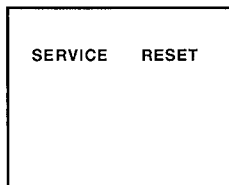

Carry out step 7 when adjusting IDs 0 to 4 and when replacing and adjusting IC003.
Factory original setting

8. Turn set off and on to exit.

2. MEMORY WRITE CONFIRMATION METHOD

1. After adjustment, pull out the plug from the AC outlet, then replace the plug in the AC outlet again.
2. Turn the power switch ON and set to service mode.
3. Call the adjusted items again to confirm they were adjusted.

3. ADJUST BUTTONS AND INDICATOR

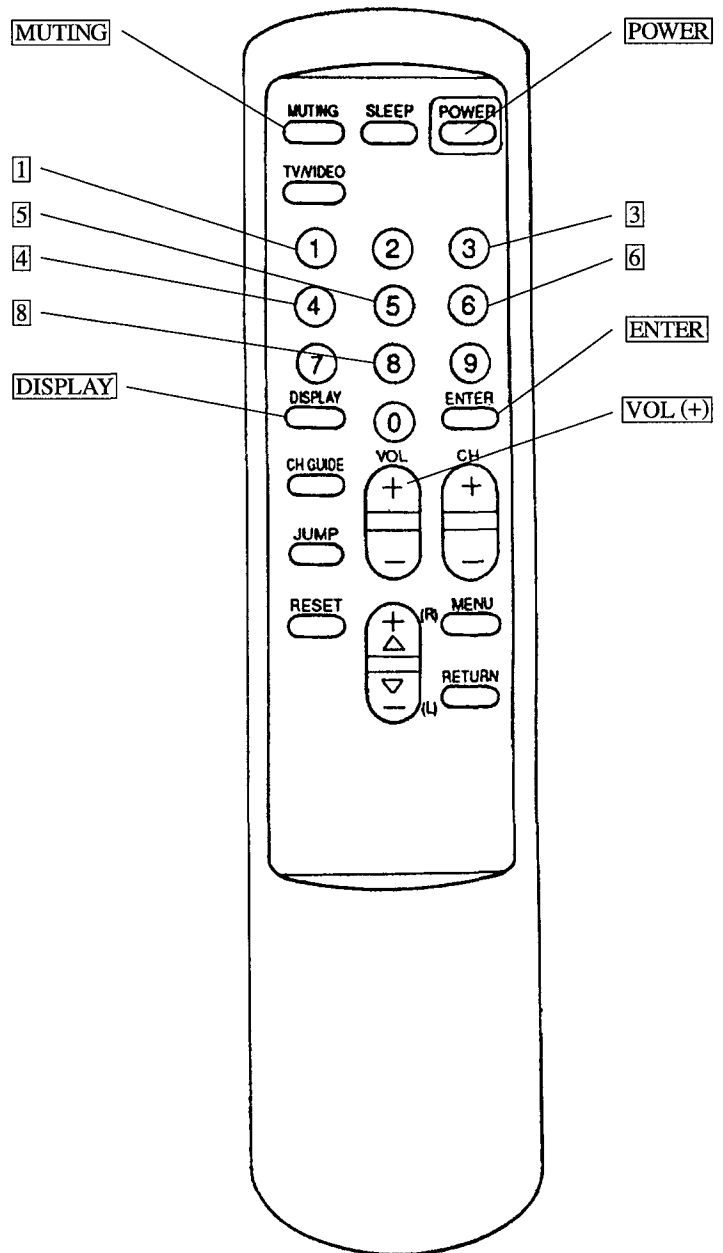

RM-Y116

4. AN ITEM OF ADJUSTMENTS

No.	Disp.	Item	Data range	Avg. data
1	SYS	Color System	0~3	1
2	AFC	AFC Loop Gain	0~3	*1
3	VPOS	V. Position	0~31	15
4	VSIZ	V. Size	0~63	22
5	VLIN	V. Linearity	0~15	6
6	VSCO	S. Correction	0~15	5
7	HPOS	H. Position	0~15	9
8	GDRV	Green-Drive	0~31	18
9	BDRV	Blue-Drive	0~31	15
10	GCUT	Green-Cutoff	0~15	6
11	BCUT	Blue Cut Off	0~15	6
12	TOT	Chroma TOT-Filter	0, 1	*1
13	NR	Noise Reduction	0, 1	*0
14	SCON	Sub-Contrast	0~15	8
15	SHUE	Sub-Hue	0~15	9
16	SCOL	Sub-Color	0~15	11
17	SBRT	Sub-Brightness	0~63	34
18	SSHP	Sub-Sharpness	0~15	9
19	RON	Red-Off	0, 1	*1
20	GON	Green-Off	0, 1	*1
21	BON	Blue-Off	0, 1	*1
22	PREL	Pre-Over Shoot	0~7	4
23	AXIS	Axis SW	0, 1	1
24	DCOL	Dynamic-Color	0, 1	*0
25	REF	Reference-Position	0~3	2
26	ABLM	ABL Mode	0~3	2
27	CROM	Chroma Trap SW	0, 1	1
28	OSDL	OSD Level	0, 1	0
29	Y-DC	DC Transmission	0~7	1
30	GAMM	Gamma	0~7	0
31	VEXT	V Sync Extend	0, 1	1
32	VZOM	HV Comp	0~7	4
33	CDMD	V Countdown	0, 1	0
34	RGBL	RGB Limit	0~3	0
35	YDLY	Y Delay	0~3	0
36	SBAL	Left-Volume	0~15	7
37	SBAS	Sub-Bass	0~15	7
38	STRE	Sub-Treble	0~15	7
39	PHOR	Horizontal Size	0~63	15
40	PE-W	E-W Correction	0~63	30
41	PCOR	E-W Corner	0~15	8
42	PTRP	Trap Correction	0~63	0
43	HCMP	H Compensation	0~15	8
44	DISP	Display Position	0~63	8
45	PADJ	B+ Adjustment	0~63	38
46	ID-0	ID-0	0~256	by Model
47	ID-1	ID-1	0~256	by Model
48	ID-2	ID-2	0~256	by Model
49	ID-3	ID-3	0~256	by Model
50	ID-4	ID-4	0~256	by Model

* · Set-up value

Note: No.1 through 50 show adjustment order.

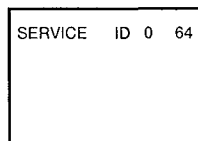

Note: IC001 on circuit board A inputs a V. Sync signal to pin ⑤ and is always in operation. If a V. Sync signal is input to pin ⑤ there will be a waiting period of 2-4 seconds, and the power is shut off. When entering the service mode, the above function is cancelled and operation is possible.

Adjust the function values as shown below when IC003 on A board is replaced.

KV-13M20 (CND)			KV-13M20 (US)		
No.	Disp.	Data	No.	Disp.	Data
46	ID-0	9	46	ID-0	25
47	ID-1	1	47	ID-1	1
48	ID-2	0	48	ID-2	0
49	ID-3	0	49	ID-3	0
50	ID-4	17	50	ID-4	17

KV-13M30/13M31(US)			KV-14R20(E)/14RD1/14PM1(MEX)		
No.	Disp.	Data	No.	Disp.	Data
46	ID-0	25	46	ID-0	25
47	ID-1	3	47	ID-1	1
48	ID-2	0	48	ID-2	0
49	ID-3	0	49	ID-3	2
50	ID-4	19	50	ID-42	17

5-2. A BOARD ADJUSTMENTS

RF AGC ADJUSTMENT (IF BLOCK VR)

1. Input a color-bar signal.
2. Adjust AGC VR of TU101 so that snow, noise, and cross-modulation disappear from the picture.
3. Verify picture quality on each channel.

H. FREQUENCY ADJUSTMENT

1. Input a monoscope signal.
2. Set to Service adjustment Mode.
3. Connect a frequency counter to base of Q550 (TP-86 H. DRIVE).
4. Select the item of AFC, set to 3 level (free run).
5. Check H. Frequency for the 15734 ± 60 Hz.
6. Select the item of AFC again, adjust the level "0".
7. Write into the memory by pressing **MUTING** then **ENTER**.

V. FREQUENCY ADJUSTMENT

1. Select video 1 with no signal input.
2. Set the conditions with standard setting.
3. Connect a capacitor (10 μ F) across pin ④ of IC301 (V. SYNC) and ground.
4. Connect the frequency counter across CN501 VDY (+) connector and ground.
5. Check V. Frequency for the 59 ± 0.5 Hz
6. Disconnect the capacitor from IC301.

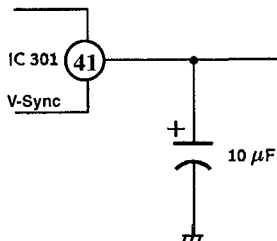

CHROMA TRAP ADJUSTMENT (CROM)

1. Input a red signal.
2. Set to Service adjustment Mode.
3. Connect an oscilloscope CN703 Pin ① (R OUT) of C board ground.
4. Select CROM with **1** and **4**.
5. Adjust with **3** and **6** for the 0 level.

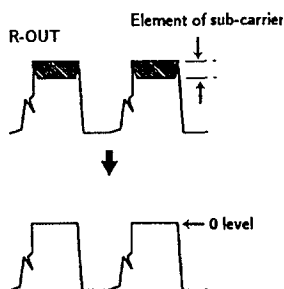

6. Write into the memory by pressing **MUTING** then **ENTER**.

SUB CONTRAST ADJUSTMENT (SCON)

1. Input a color-bar signal.
2. Select the red color.
3. Set to Service adjustment Mode.
4. Set the conditions as follows.

PICTURE MAX
 COLOR MIN
 BRIGHT CENTER

R ON ON (1)
 G ON OFF (0)
 B ON OFF (0)

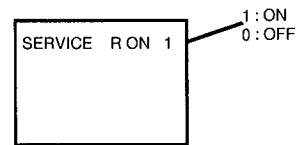

5. Connect an oscilloscope to CN703 Pin ① (R OUT) of C board and ground.
6. Select SCON with **1** and **4**.
7. Adjust with **3** and **6** for the 1.9 ± 0.05 Vp-p.

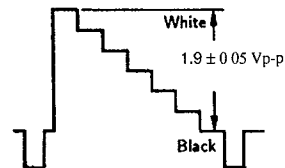

8. Write the memory by pressing **MUTING** then **ENTER**.
9. Return the following back to normal after adjustment.

PICTURE MAX
 COLOR CENTER
 BRIGHT CENTER

R ON ON (1)
 G ON ON (1)
 B ON ON (1)

DISPLAY POSITION ADJUSTMENT (DISP)

1. Input a color-bar signal.
2. Set to Service adjustment Mode.
3. Select DISP with **1** and **4**.
4. Adjust with **3** and **6** for the bar center.
5. Write the memory by pressing **MUTING** then **ENTER**.
6. Check if the text is displayed on the screen.

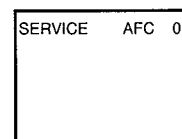

SUB BRIGHT ADJUSTMENT (SBRT)

1. Input a cross-hatch signal.
2. Set to Service adjustment Mode.
3. Set the PICTURE and BRIGHT to minimum.
4. Select SBRT with **[1]** and **[4]**.
5. Adjust with **[3]** and **[6]** to obtain a faintly visible cross-hatch.
6. Write into the memory by pressing **[MUTING]** then **[ENTER]**.

SUB HUE, SUB COLOR ADJUSTMENT (SHUE, SCOL)

1. Input a color-bar signal.
2. Set to Service adjustment Mode.
3. Connect an oscilloscope to CN703 Pin ③ (B OUT) of C board.
4. Select SHUE and SCOL with **[1]** and **[4]**.
5. Adjust with **[3]** and **[6]** for the $V1 = V4$ (SCOL) and $V2 = V3$ (SHUE).

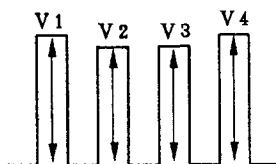

6. Write into the memory by pressing **[MUTING]** then **[ENTER]**.

V. SIZE ADJUSTMENT (VSIZ)

1. Input a cross-hatch signal.
2. Set to Service adjustment Mode.
3. Select VSIZ with **[1]** and **[4]**.
4. Adjust with **[3]** and **[6]** for the best vertical size.
5. Write into the memory by pressing **[MUTING]** then **[ENTER]**.



V. CENTER ADJUSTMENT (VPOS)

1. Input a cross-hatch signal.
2. Set to Service adjustment Mode.
3. Select VPOS with **[1]** and **[4]**.
4. Adjust with **[3]** and **[6]** for the best vertical center.
5. Write into the memory by pressing **[MUTING]** then **[ENTER]**.

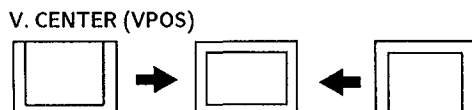

H. CENTER ADJUSTMENT (HPOS)

Note : Perform this adjustment after checking H. FREQUENCY.

1. Input a cross-hatch signal.
2. Set the Service adjustment Mode.
3. Select HPOS with **[1]** and **[4]**.
4. Adjust with **[3]** and **[6]** for the best horizontal center.
5. Write into the memory by pressing **[MUTING]** then **[ENTER]**.

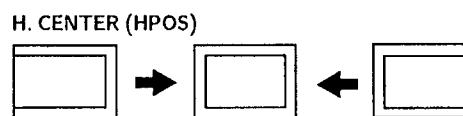

V LINEARITY (VLIN) AND V CORRECTION (VSCO) ADJUSTMENTS.

1. Input a cross-hatch signal.
2. Set to Service adjustment Mode.
3. Select VLIN and VSCO with **[1]** and **[4]**.
4. Adjust with **[3]** and **[6]** for the best picture.
5. Write the memory by pressing **[MUTING]** then **[ENTER]**.

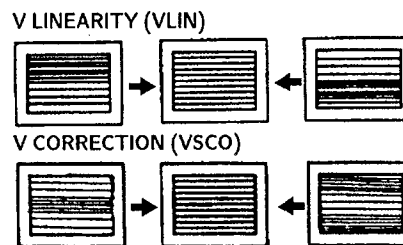

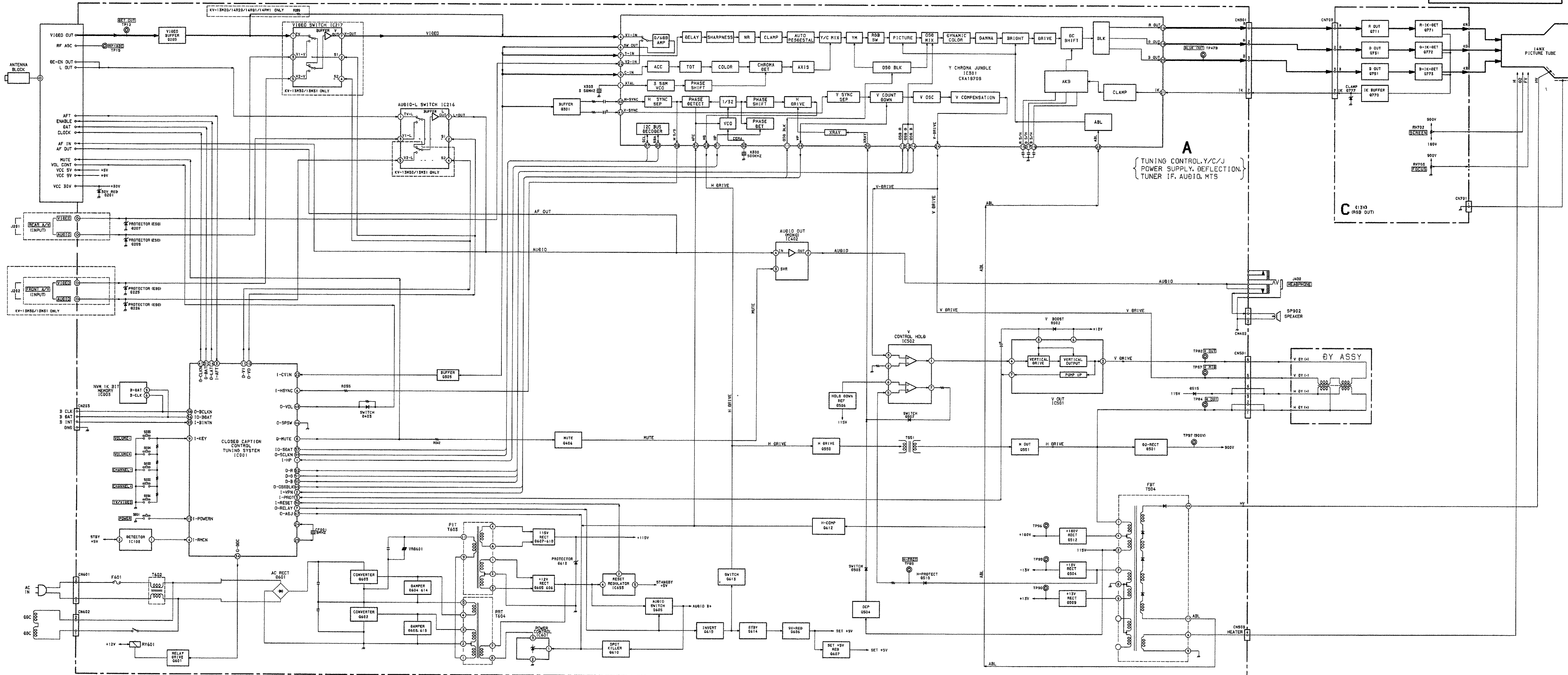

6-2. Circuit Boards Location

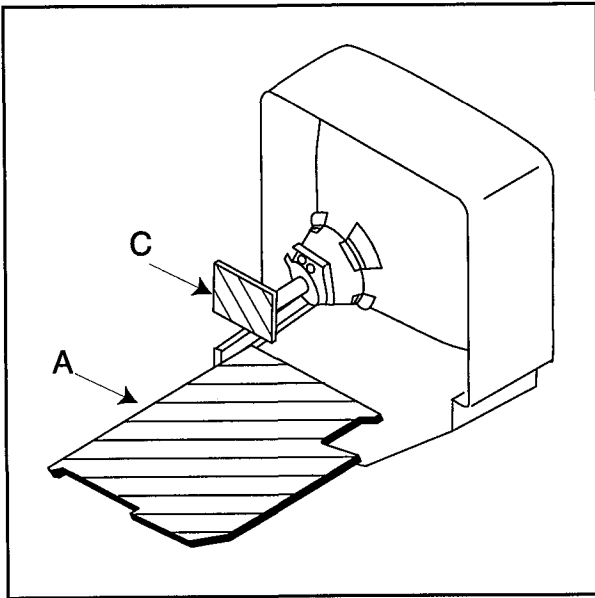

6-3. Printed Wiring Boards and Schematic Diagrams

Note:

- All capacitors are in μF unless otherwise noted. pF : $\mu\mu\text{F}$ 50WV or less are not indicated except for electrolytic and tantalums.
- All electrolytics are 50V unless otherwise specified
- Indication of resistance, which does not have one for rating electrical power, is as follows:

Pitch: 5mm
Rating electrical power 1/4W

- All resistors are in ohms.
 $\text{K}\Omega=1000\Omega$, $\text{M}\Omega=1000\text{K}\Omega$
- nonflammable resistor.
- Δ : internal component.
- : panel designation and adjustment for repair.
- All variable and adjustable resistors have characteristic curve B, unless otherwise noted.
- The components identified by in this manual have been carefully factory-selected for each set in order to satisfy regulations regarding X-ray radiation. Should replacement be required, replace only with the value originally used.
- When replacing components identified by make the necessary adjustments indicated. If results do not meet the specified value, change the component identified by and repeat the adjustment until the specified value is achieved. (Refer to R525 on pages 17 & 18).
- When replacing parts in the table below be sure to perform the related adjustment.

Part replaced ()	Adjustment ()
IC301, IC502, IC601, D505, D506, D507, D510, DY, C503, C511, C513, C528, R511, R519, R520, R523, R525, R527, R559, R560, R617, R618, R652, R653, R654, T504 (FBT)	HV HOLD-DOWN (R525)
IC001, IC601, R030, R617, R618, R629, R630, R651, R652, R653, R654, R655, R656	B+ VOLTAGE CONFIRMATION

- All voltages are in V.
- Voltage is dc with respect to ground unless otherwise noted.
- Readings are taken with a $10\text{M}\Omega$ digital multimeter.
- Readings are taken with a color-bar signal input.
- Voltage variations may be noted due to normal production tolerance.
- Circled numbers are waveform references.

- : B + Line
- : B - Line
- : signal path

Reference Information

RESISTOR	: RN	METAL FILM
	: RC	SOLID
	: FPRD	NON FLAMMABLE CARBON
	: FUSE	NON FLAMMABLE FUSIBLE
	: RW	NON FLAMMABLE WIREWOUND
	: RS	NON FLAMMABLE MET AL OXIDE
	: RB	NON FLAMMABLE CEMENT
	: \otimes	ADJUSTMENT RESISTOR
COIL	: LF-8L	MICRO INDUCTOR
CAPACITOR	: TA	TANTALUM
	: PS	STYROL
	: PP	POLYPROPYLENE
	: PT	MYLAR
	: MPS	METALIZED POLYESTER
	: MPP	METALIZED POLYPROPYLENE
	: ALB	BIPOLAR
	: ALT	HIGH TEMPERATURE
	: ALR	HIGH RIPPLE

Note: The symbol display is on the component side.

The components identified by shading and mark Δ are critical for safety. Replace only with part number specified.

The symbol indicates fast operating fuse. Replace only with fuse of same rating as marked.

A

TUNING CONTROL, Y/C/J,
POWER SUPPLY, DEFLECTION,
TUNER/IF, AUDIO MTS

— A BOARD —

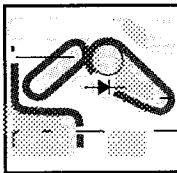

NOTE:
The circuit indicated as left contains high voltage of over 600Vp-p. Care must be taken to prevent an electric shock during inspection or repair in these areas.

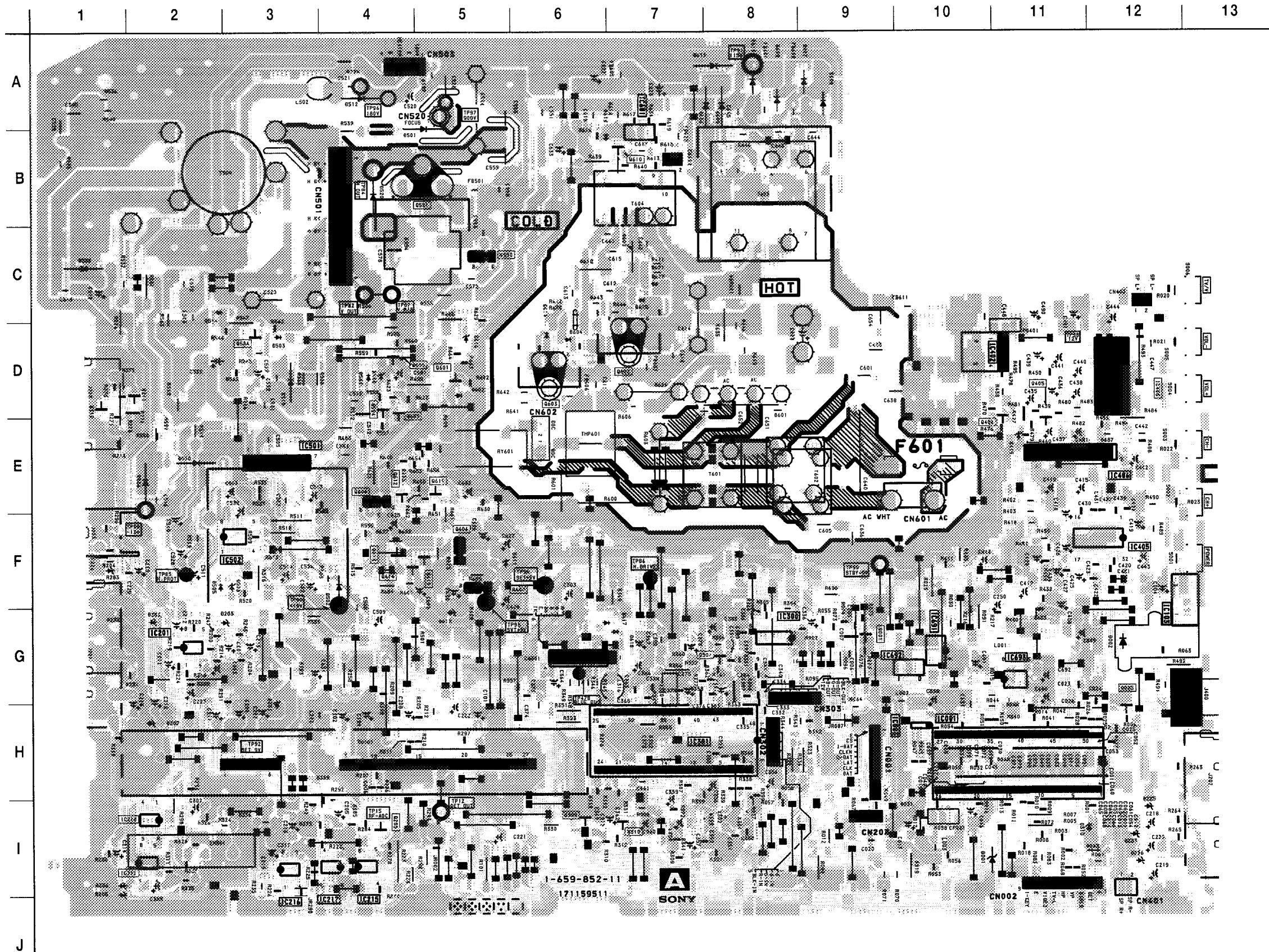

IC		DIODE	
IC001	H-10	D001	I-10
IC003	H-9	D201	H-3
IC103	G-12	D203	G-3
IC201	G-2	D205	I-1
IC215	J-4	D206	I-1
IC216	J-3	D207	H-2
IC217	J-4	D225	I-12
IC301	H-7	D226	I-12
IC402	D-10	D227	I-12
IC406	E-12	D310	I-11
IC408	D-12	D403	G-11
IC501	E-3	D415	E-11
IC502	F-3	D501	B-4
IC601	A-7	D502	F-4
IC693	G-11	D503	D-3
TRANSISTOR		D504	E-2
Q205	I-4	D505	F-2
Q210	D-1	D506	F-3
Q211	D-2	D507	D-4
Q301	G-8	D509	C-1
Q305	I-6	D510	E-2
Q405	D-11	D512	A-4
Q406	E-10	D514	C-2
Q504	D-3	D515	D-3
Q550	C-5	D601	D-8
Q551	B-5	D602	D-5
Q601	D-5	D603	C-7
Q602	D-7	D604	D-6
Q603	D-6	D605	A-8
Q605	D-4	D606	A-7
Q606	F-5	D607	A-9
Q607	F-6	D608	A-9
Q610	B-7	D609	A-8
Q612	E-4	D610	A-8
Q613	F-4	D611	F-5
Q614	F-4	D612	G-5
Q615	F-5	D613	A-8
		D614	C-6
		D615	C-7
		D619	A-6

. A BOARD WAVEFORMS

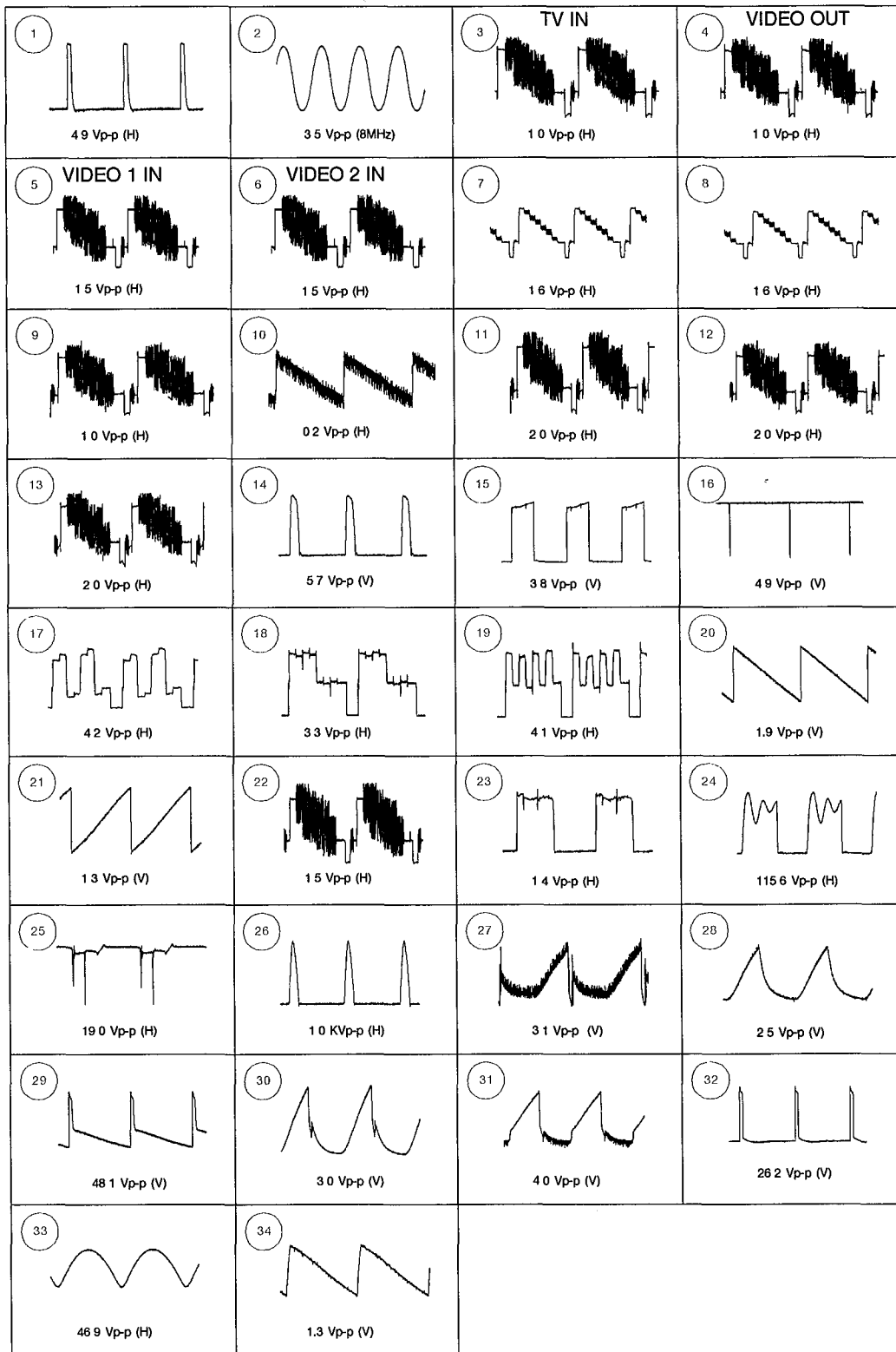

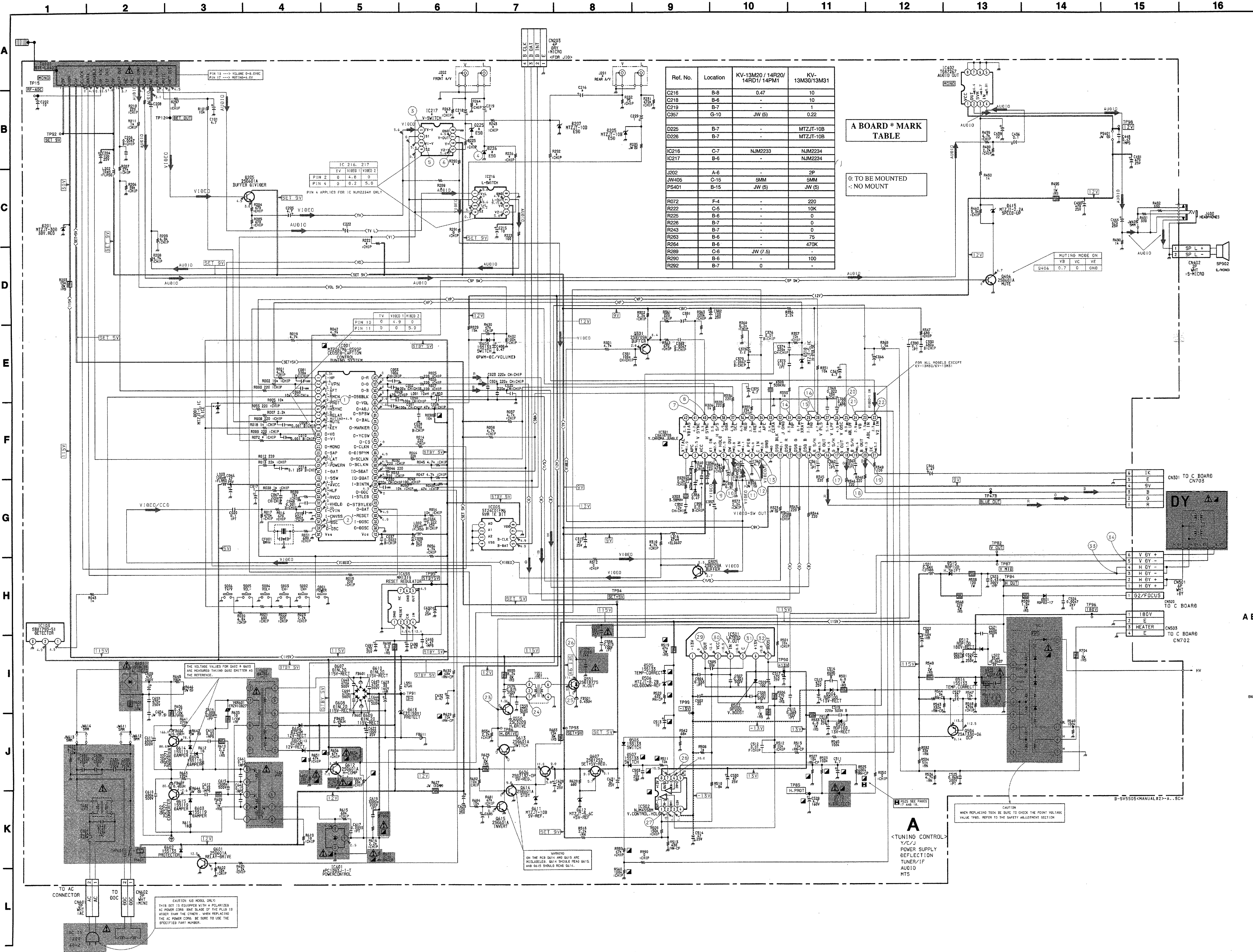

Ref. No. **Location** **KV-13M20 / 14R20/14RD1/14PM1** **KV-13M30/13M31**

C216	B-8	0.47	10
C218	B-6	-	10
C219	B-7	-	1
C357	G-10	JW (5)	0.22
D225	B-7	-	MTZJT-10B
D226	B-7	-	MTZJT-10B
IC216	C-7	NJM2233	NJM2234
IC217	B-6	-	NJM2234
L202	A-6	-	2P
JW405	C-15	5MM	5MM
PS401	B-15	JW (5)	-
R072	F-4	-	220
R222	C-5	-	10K
R225	B-6	-	0
R226	B-7	-	0
R243	B-7	-	0
R263	B-6	-	75
R264	B-6	-	470K
R289	C-6	JW (7.5)	-
R290	B-6	-	100
R292	B-7	0	-

A BOARD * MARK TABLE
0: TO BE MOUNTED
-: NO MOUNT

A BOARD IC402 TDA7267

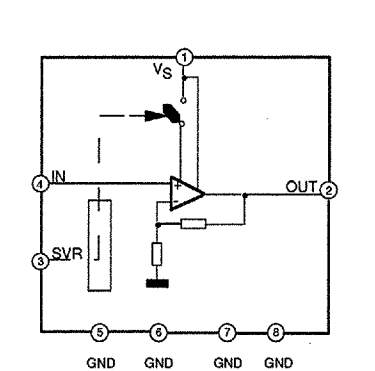

A BOARD IC216 NJM2233BM

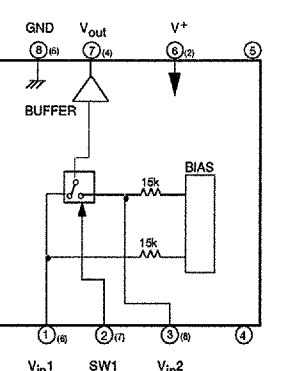

A BOARD IC216, 217 NJM 2234BM

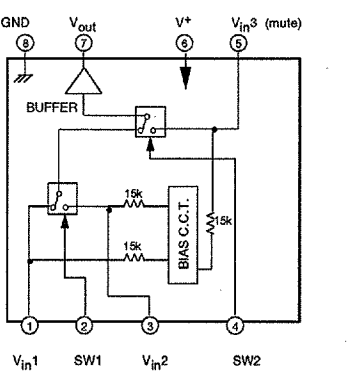

A BOARD IC301 CXA1870S

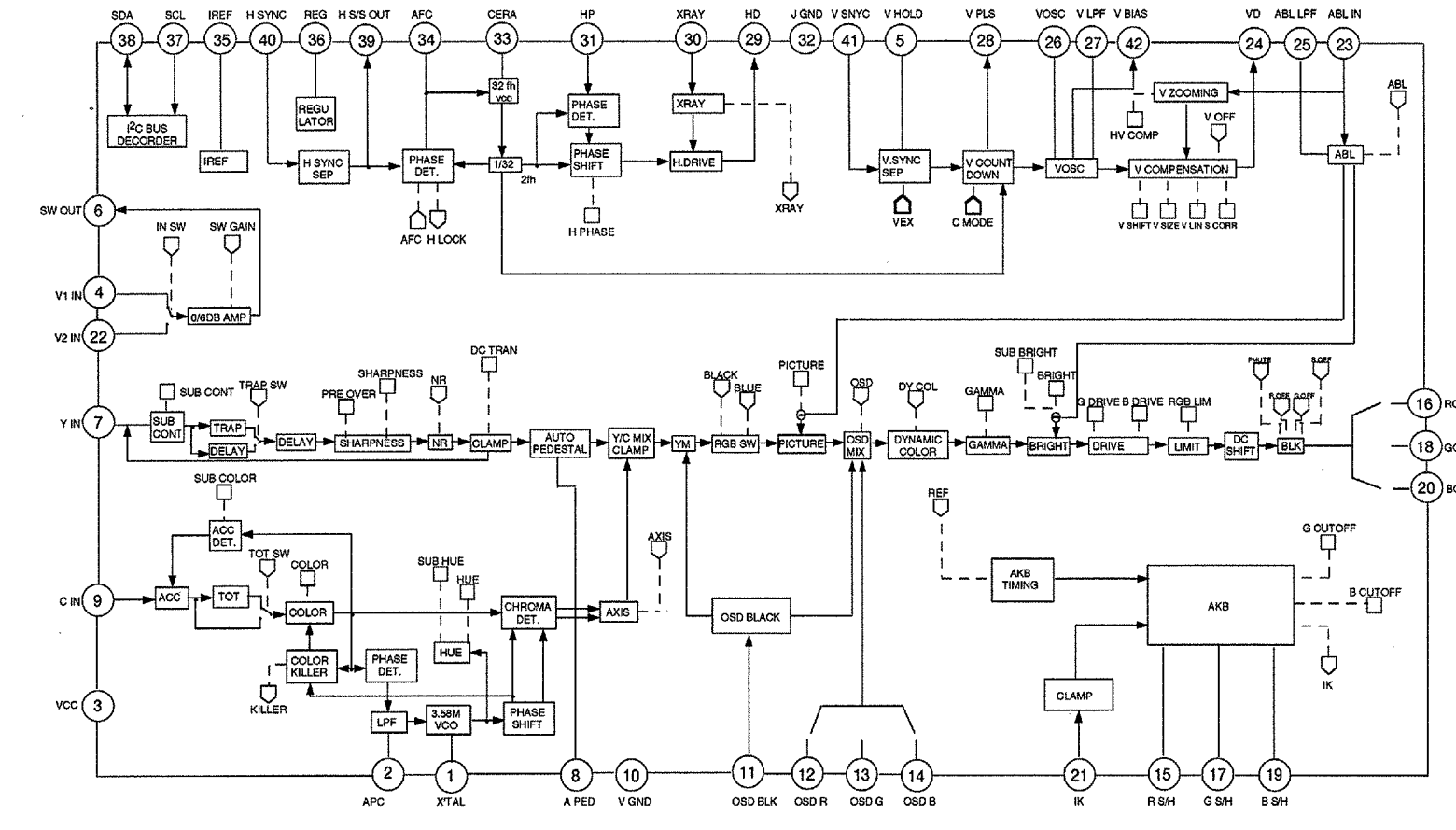

CAUTION: IC301 MODEL ONLY
THIS SET IS EQUIPPED WITH A POLARIZED AC POWER CORD. THE BLADE OF THE PLUG IS WIDER THAN THE OTHER. WHEN REPLACING THE AC POWER CORD, BE SURE TO USE THE SPECIFIED PART NUMBER.

A <TUNING CONTROL>
V/C/J
POWER SUPPLY
REFLECTOR
TUNER/IF
AUDIO
MTS

WHEN REPLACING TSD, BE SURE TO CHECK THE POINT VOLTAGE VALUE FIRST. REFER TO THE SAFETY ADJUSTMENT SECTION.

6-4. SEMICONDUCTORS

TDA7267

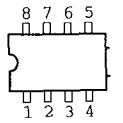

TOP VIEW

LA7830

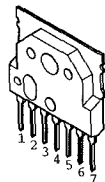

uPC1093J-1-T

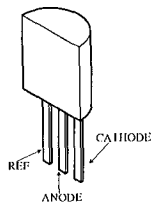

TDA2009A

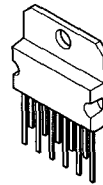

- 1SS119-25TD
- 1SS133T-77
- MTZJ-T-77-10B
- MTZJ-T-77-2.2
- MTZJ-T-77-3.3B
- MTZJ-T-77-30D
- MTZJ-T-77-5.1C
- MTZJ-T-77-5.6C
- MTZJ-T-77-8.2B

D3SB60F

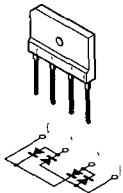

D1NL20-TA
EL1Z-V1
RGP10GPKG3

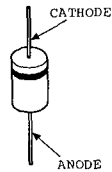

GP08DPKG3

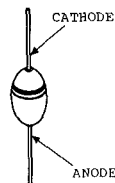

D2S4MTA1

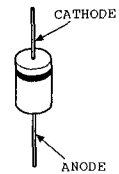
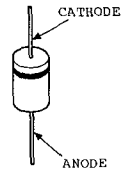

NJM2233BM(TE2)
NJM2234(TE2)
NJM4558M-TE2

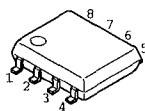

2SD2137-OP-TA

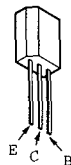

2SD1877S-SONY-CA

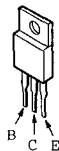

2SC3209LK-TP
2SD1292

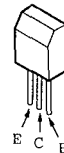

2SA1330-T106
2SB709A-QRS-TX
2SD601A-QRS-TX

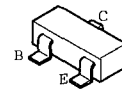

2SC5271-ROYG-F

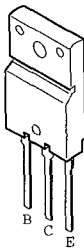

2SA1091-0

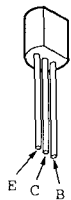

2SC2611

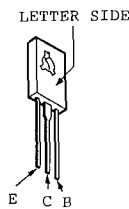

2SA1175-HFE

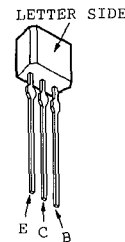

SBX1790-51

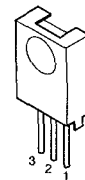

M37267M6 - 059SP

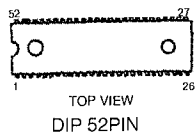

CXA1870S

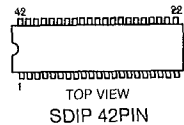

uPC1406HA

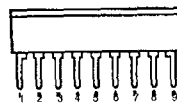

ST24C01FM6TR

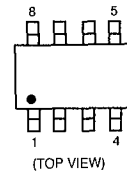

MM1319

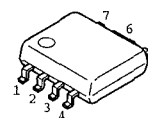

SECTION 7 EXPLODED VIEWS

The components identified by shading and mark Δ are critical for safety. Replace only with part number specified.

NOTE :

- Items with no part number and no description are not stocked because they are seldom required for routine service
- The construction parts of an assembled parts are indicated with a collation number in the remark column

- Items marked " * " are not stocked since they are seldom required for routine service. Some delay should be anticipated when ordering these items

7-1. CHASSIS

■ BVTP 4x16 7-685-663-79

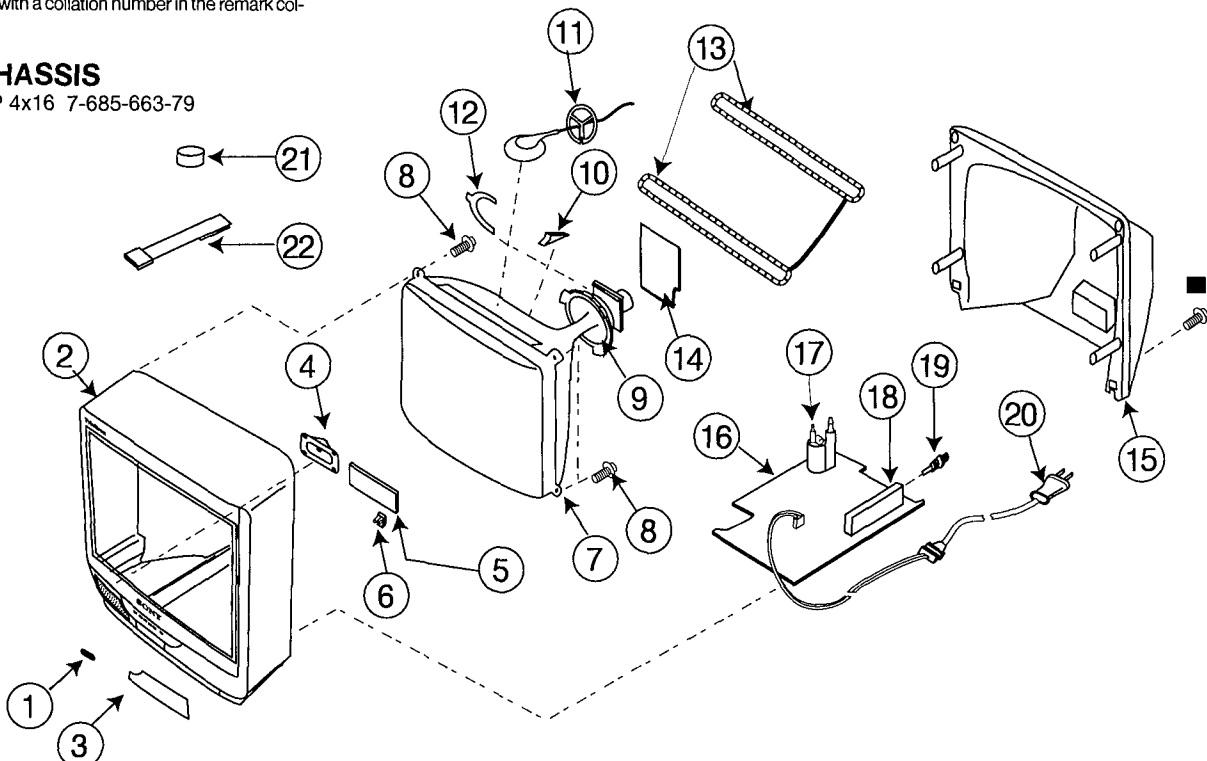

REF.NO.	PART NO.	DESCRIPTION	REMARK
1	4-046-162-01	EMBLEM (NO 6) SONY	
2	4-051-571-01	BEZNET	(KV-13M30)
	4-051-571-11	BEZNET	(KV-13M31)
	4-051-571-21	BEZNET	(KV-13M20/14PM1)
	4-051-571-31	BEZNET	(KV-14R20)
	4-051-571-41	BEZNET	(KV-14RD1)
3	4-051-569-01	DOOR, CONTROL	(KV-13M30/13M20/14R20/14RD1/14PM1)
	4-051-569-11	DOOR, CONTROL	(KV-13M31)
4	1-505-265-11	SPEAKER (9X5CM)	
5	4-051-567-01	BUTTON, MULTI	(KV-13M30/13M20/14R20/14RD1/14PM1)
	4-051-567-11	BUTTON, MULTI	(KV-13M31)
6	4-051-568-01	FILTER, REMOTE	
7	Δ 8-735-562-00	CR3 14NDX	
8	4-365-808-01	SCREW (5), TAPPING	
9	Δ 8-451-418-11	DY YLANDZ	
10	4-053-005-01	SPACER, DY	
11	3-704-372-31	HOLDER, HV CABLE	
12	1-452-277-00	MAGNET, BMC	
13	Δ 1-426-146-21	COIL, DEMAGNETIZATION	
14	* A-1331-519-A	MOUNTED PCB, C	
15	4-051-570-01	REAR COVER	(KV-13M30/13M20/14R20/14RD1/14PM1)
	4-051-570-11	REAR COVER	(KV-13M31)

REF.NO.	PART NO.	DESCRIPTION	REMARK
16	* A-1297-785-A	COMPLETE (PCB,A)	(KV-13M20/14R20/14RD1/14PM1)
	* A-1297-714-A	COMPLETE (PCB,A)	(KV-13M30/13M31)
17	Δ 1-453-210-11	TRANSFORMER ASSY, FLYBACK (NX1731)	
18	Δ 8-598-339-00	TUNER BTF-LA402	
19	1-766-374-11	PLUG, F PIN	
20	Δ 1-751-058-11	CORE, POWER (WITH CONNECTOR) 10A/125V	(KV-13M30/13M20/14R20/14RD1/14PM1)
	Δ 1-751-058-12	CORE, POWER (WITH CONNECTOR) 10A/125V	(KV-13M31)
21	1-452-032-00	MAGNET, DISC	
22	X-4308-815-0	PERMALLOY ASSY, CONVERGENCE	



SECTION 8 ELECTRICAL PARTS LIST

Note:

The components identified by shading and mark Δ are critical for safety
Replace only with part number specified

- Items marked " * " are not stocked since they are seldom required for routine service. Some delay should be anticipated when ordering these items.
- All variable and adjustable resistors have characteristic curve B, unless otherwise noted.

RESISTORS

- All resistors are in ohms
- F : nonflammable

When indicating parts by reference number, please include the board name.

CAPACITORS

MF : μ F, PF : μ μ F

COILS

MMH : mH, μ H : μ H

- The components identified by \boxtimes in this manual have been carefully factory-selected for each set in order to satisfy regulations regarding X-ray radiation. Should replacement be required, replace only with the value originally used.

REF.NO.	PART NO.	DESCRIPTION	REMARK	REF.NO.	PART NO.	DESCRIPTION	REMARK
*	A-1297-714-A	A BOARD COMPLETE (KV-13M30/13M31)		C215	1-126-964-11	ELECT 10MF 20% 50V	
*	A-1297-785-A	A BOARD COMPLETE (KV-13M20/14R20/14RD1/14PM1)		C216	1-124-902-00	ELECT 0.47MF 20% 50V (KV-13M20/14R20/14RD1/14PM1)	

	1-533-223-11	HOLDER, FUSE		C216	1-126-964-11	ELECT 10MF 20% 50V (KV-13M30/13M31)	
*	1-900-800-66	CONNECTOR ASSY, 4P MINI MICRO		C218	1-126-964-11	ELECT 10MF 20% 50V (KV-13M30/13M31)	
*	1-900-800-67	CONNECTOR ASSY, 6P MINI MICRO		C219	1-124-903-11	ELECT 1MF 20% 50V (KV-13M30/13M31)	
	4-382-854-11	SCREW (M3X10), P, SW (+)		C222	1-124-903-11	ELECT 1MF 20% 50V	
	7-682-949-01	SCREW + PSW 3X10		C229	1-124-903-11	ELECT 1MF 20% 50V	
<CAPACITOR>							
C001	1-163-125-00	CERAMIC CHIP 220pF 5% 50V		C301	1-163-251-11	CERAMIC CHIP 100pF 5% 50V	
C008	1-163-009-11	CERAMIC CHIP 0.001MF 10% 50V		C315	1-104-664-11	ELECT 47MF 20% 25V	
C010	1-163-009-11	CERAMIC CHIP 0.001MF 10% 50V		C330	1-163-007-11	CERAMIC CHIP 680pF 10% 50V	
C014	1-164-004-11	CERAMIC CHIP 0.1MF 10% 25V		C352	1-163-229-11	CERAMIC CHIP 12pF 5% 50V	
C017	1-124-903-11	ELECT 1MF 20% 50V		C353	1-163-005-11	CERAMIC CHIP 470pF 10% 50V	
C019	1-163-135-00	CERAMIC CHIP 560pF 5% 50V		C354	1-124-902-00	ELECT 0.47MF 20% 50V	
C020	1-137-399-11	FILM 0.1MF 5% 50V		C355	1-164-232-11	CERAMIC CHIP 0.01MF 10% 50V	
C023	1-163-125-00	CERAMIC CHIP 220pF 5% 50V		C356	1-126-934-11	ELECT 220MF 20% 16V	
C024	1-163-125-00	CERAMIC CHIP 220pF 5% 50V		C357	1-124-464-11	ELECT 0.22MF 20% 50V (KV-13M30/13M31)	
C025	1-163-125-00	CERAMIC CHIP 220pF 5% 50V		C358	1-124-902-00	ELECT 0.47MF 20% 50V	
C026	1-163-243-11	CERAMIC CHIP 47pF 5% 50V		C359	1-124-902-00	ELECT 0.47MF 20% 50V	
C028	1-163-005-11	CERAMIC CHIP 470pF 10% 50V		C360	1-126-963-11	ELECT 4.7MF 20% 50V	
C030	1-163-125-00	CERAMIC CHIP 220pF 5% 50V		C361	1-137-399-11	FILM 0.1MF 5% 50V	
C034	1-163-037-11	CERAMIC CHIP 0.022MF 10% 50V		C362	1-137-399-11	FILM 0.1MF 5% 50V	
C037	1-164-161-11	CERAMIC CHIP 0.0022MF 10% 50V		C363	1-137-399-11	FILM 0.1MF 5% 50V	
C038	1-126-941-11	ELECT 470MF 20% 25V		C364	1-124-902-00	ELECT 0.47MF 20% 50V	
C046	1-104-664-11	ELECT 47MF 20% 25V		C366	1-124-903-11	ELECT 1MF 20% 50V	
C047	1-163-125-00	CERAMIC CHIP 220pF 5% 50V		C367	1-126-963-11	ELECT 4.7MF 20% 50V	
C048	1-163-009-11	CERAMIC CHIP 0.001MF 10% 50V		C368	1-136-169-00	FILM 0.22MF 5% 50V	
C050	1-163-251-11	CERAMIC CHIP 100pF 5% 50V		C369	1-163-037-11	CERAMIC CHIP 0.022MF 10% 50V	
C051	1-163-251-11	CERAMIC CHIP 100pF 5% 50V		C373	1-137-370-11	FILM 0.01MF 5% 50V	
C052	1-163-251-11	CERAMIC CHIP 100pF 5% 50V		C374	1-163-125-00	CERAMIC CHIP 220pF 5% 50V	
C053	1-163-251-11	CERAMIC CHIP 100pF 5% 50V		C375	1-126-963-11	ELECT 4.7MF 20% 50V	
C060	1-163-227-11	CERAMIC CHIP 10pF 0.5pF 50V		C376	1-164-232-11	CERAMIC CHIP 0.01MF 10% 50V	
C101	1-126-963-11	ELECT 4.7MF 20% 50V		C378	1-124-925-11	ELECT 2.2MF 20% 50V	
C202	1-126-964-11	ELECT 10MF 20% 50V		C379	1-163-017-00	CERAMIC CHIP 4700PF 10% 50V	
C204	1-104-665-11	ELECT 100MF 20% 25V		C381	1-124-903-11	ELECT 1MF 20% 50V	
C205	1-124-902-00	ELECT 0.47MF 20% 50V					
C206	1-163-017-00	CERAMIC CHIP 0.0047MF 10% 50V					
C208	1-124-903-11	ELECT 1MF 20% 50V					

The components identified by shading and mark Δ are critical for safety
 Replace only with part number specified

A

REF.NO.	PART NO.	DESCRIPTION	REMARK
C382	1-104-665-11	ELECT	100MF 20% 25V
C383	1-163-017-00	CERAMIC CHIP	0.0047MF 10% 50V
C390	1-137-399-11	FILM	0.1MF 5% 50V
C408	1-124-902-00	ELECT	0.47MF 20% 50V
C436	1-126-956-91	ELECT	0.1MF 20% 50V
C439	1-126-965-11	ELECT	22MF 20% 50V
C444	1-126-941-11	ELECT	470MF 20% 25V
C448	1-136-173-00	FILM	0.47MF 5% 50V
C490	1-126-941-11	ELECT	470MF 20% 25V
C491	1-126-941-11	ELECT	470MF 20% 25V
C502	1-126-965-11	ELECT	22MF 20% 50V
C503	1-107-698-11	ELECT	10MF 20% 25V
C504	1-130-489-00	FILM	0.033MF 5% 50V
C505	1-102-963-00	CERAMIC	33pF 5% 50V
C507	1-102-038-00	CERAMIC	0.001MF 500V
C508	1-102-038-00	CERAMIC	0.001MF 500V
C509	1-126-968-11	ELECT	100MF 20% 50V
C510	1-108-702-11	MYLAR	0.068MF 10% 100V
C521 Δ	1-126-963-11	ELECT	4.7MF 20% 50V
C512	1-163-031-11	CERAMIC	0.01MF 50V
C513	1-126-964-11	ELECT	10MF 20% 50V
C514	1-104-664-11	ELECT	47MF 20% 25V
C515	1-126-941-11	ELECT	470MF 20% 25V
C516	1-102-244-00	CERAMIC	220pF 10% 500V
C517	1-126-941-11	ELECT	470MF 20% 25V
C518	1-126-941-11	ELECT	470MF 20% 25V
C519	1-102-244-00	CERAMIC	220pF 10% 500V
C520	1-107-652-11	ELECT	10MF 20% 250V
C521	1-102-244-00	CERAMIC	220pF 10% 500V
C522	1-123-024-21	ELECT	33MF 160V
C523	1-136-108-00	FILM	0.43MF 5% 200V
C525	1-106-387-00	MYLAR	0.068MF 10% 200V
C526	1-162-114-00	CERAMIC	4700PF 2.0KV
C527	1-126-965-11	ELECT	22MF 20% 50V
C528 Δ	1-167-635-11	ELECT	4.7MF 20% 160V
C530	1-164-664-11	ELECT	47MF 20% 25V
C553	1-102-228-00	CERAMIC	470pF 10% 500V
C554 Δ	1-164-773-11	FILM	6800PF 2% 2.0KV
C558	1-106-371-00	MYLAR	0.015MF 10% 100V
C559 Δ	1-162-113-03	CERAMIC	330PF 18% 25V
C575	1-106-371-06	MYLAR	0.015MF 200V
C579 Δ	1-108-371-08	MYLAR	0.015MF 10% 100V
C631 Δ	1-113-920-11	ELECT	0.0022MF 20% 250V
C605 Δ	1-113-920-11	ELECT	0.0022MF 20% 250V
C609	1-104-759-11	ELECT	470MF 20% 200V
C610	1-164-625-11	CERAMIC	680PF 10% 500V
C611	1-164-625-11	CERAMIC	680PF 10% 500V
C612	1-136-171-00	FILM	0.33MF 5% 50V
C613	1-136-171-00	FILM	0.33MF 5% 50V
C614	1-136-759-11	FILM	0.039MF 5% 630V
C615	1-164-735-11	CERAMIC	1500PF 10% 500V
C617	1-137-367-11	FILM	0.0033MF 5% 50V
C619	1-106-355-12	MYLAR	0.0033MF 10% 200V
C622	1-126-942-61	ELECT	1000MF 20% 25V

REF.NO.	PART NO.	DESCRIPTION	REMARK
C623	1-123-024-21	ELECT	33MF 160V
C625	1-104-665-11	ELECT	100MF 20% 25V
C628	1-104-664-11	ELECT	47MF 20% 25V
C631	1-104-664-11	ELECT	47MF 20% 25V
C632	1-124-902-00	ELECT	0.47MF 20% 50V
C638 Δ	1-113-920-11	ELECT	0.0022MF 20% 250V
C638 Δ	1-113-920-11	ELECT	0.0022MF 20% 250V
C640 Δ	1-136-113-11	FILM	0.47MF 20% 125V
C641	1-136-167-00	FILM	0.15MF 5% 50V
C642	1-136-167-00	FILM	0.15MF 5% 50V
C643	1-165-127-11	CERAMIC	470pF 10% 500V
C644	1-165-127-11	CERAMIC	470pF 10% 500V
C645	1-165-127-11	CERAMIC	470pF 10% 500V
C646	1-165-127-11	CERAMIC	470pF 10% 500V
C653	1-113-910-11	CERAMIC	470PF 10% 250V
C685	1-124-903-11	ELECT	1MF 20% 50V
C690	1-124-902-00	ELECT	0.47MF 20% 50V
C691	1-126-941-11	ELECT	470MF 20% 25V
C692	1-104-664-11	ELECT	47MF 20% 25V
C693	1-136-173-00	FILM	0.47MF 5% 50V
<FILTER>			
CF001	1-579-952-21	VIBRATOR, CERAMIC	
<CONNECTOR>			
CN203 *	1-560-124-00	PLUG, CONNECTOR (2.5MM) 4P	
CN402	1-564-505-11	PLUG, CONNECTOR 2P	
CN501 *	1-580-798-11	CONNECTOR PIN (DY) 6P	
CN601 *	1-580-843-11	PIN, CONNECTOR (POWER)	
CN602 *	1-508-786-00	PIN, CONNECTOR (5MM PITCH) 2P	
<DIODE>			
D001	8-719-921-44	DIODE MTZJ-5.1C	
D201	8-719-982-22	DIODE MTZJ-30D	
D205	8-719-110-17	DIODE RD10ESB2	
D207	8-719-110-17	DIODE RD10ESB2	
D225	8-719-110-17	DIODE RD10ESB2 (KV-13M30/13M31)	
D226	8-719-110-17	DIODE RD10ESB2 (KV-13M30/13M31)	
D310	8-719-921-44	DIODE MTZJ-5.1C	
D403	8-719-991-33	DIODE 1SS133T-77	
D415	8-719-982-96	DIODE MTZJ-T-77-2.2A	
D501	8-719-028-72	DIODE RGP02-17EL-6433	
D502	8-719-908-03	DIODE GP08D	
D503	8-719-991-33	DIODE 1SS133T-77	
D504	8-719-302-43	DIODE EL1Z	
D505	8-719-991-33	DIODE 1SS133T-77	
D506	8-719-110-08	DIODE RD8 2ES-B2	
D507	8-719-991-33	DIODE 1SS133T-77	
D509	8-719-302-43	DIODE EL1Z	
D510 Δ	8-719-302-43	DIODE EL1Z	
D512	8-719-302-43	DIODE EL1Z	
D514	8-719-991-33	DIODE 1SS133T-77	
D515	8-719-302-43	DIODE EL1Z	



The components identified by shading and mark Δ are critical for safety
 Replace only with part number specified

REF.NO.	PART NO.	DESCRIPTION	REMARK
D602	8-719-510-51	DIODE D3SB60P	
D602	8-719-991-33	DIODE 1SS133T-77	
D603	8-719-911-19	DIODE 1SS119-25	
D604	8-719-911-19	DIODE 1SS119-25	
D605	8-719-022-97	DIODE D2S4MF	
D606	8-719-022-97	DIODE D2S4MF	
D607	8-719-510-26	DIODE D1NL20	
D608	8-719-510-26	DIODE D1NL20	
D609	8-719-510-26	DIODE D1NL20	
D610	8-719-510-26	DIODE D1NL20	
D611	8-719-110-17	DIODE RD10ESB2	
D612	8-719-109-89	DIODE RD5.6ESB2	
D613	8-719-057-53	DIODE EZ0150V1	
D614	8-719-911-19	DIODE 1SS119-25	
D615	8-719-911-19	DIODE 1SS119-25	
<FUSE>			
F602	1-576-193-18	FUSE 6.3A / 125V	
<FERRITE BEAD>			
FB501	1-410-396-41	FERRITE BEAD INDUCTOR 0.45UH	
FB601	1-412-911-11	INDUCTOR, FERRITE BEAD	
FB602	1-412-911-11	INDUCTOR, FERRITE BEAD	
FB605	1-410-396-41	FERRITE BEAD INDUCTOR 0.45UH	
FB606	1-410-396-41	FERRITE BEAD INDUCTOR 0.45UH	
FB607	1-410-396-41	FERRITE BEAD INDUCTOR 0.45UH	
FB611	1-412-911-11	INDUCTOR, FERRITE BEAD	
<IC>			
IC001	8-759-390-31	IC M37267M6-059SP	
IC003	8-759-354-27	IC ST24C01FM6TR	
IC103	8-747-905-11	IC SBX1790-51	
IC216	8-759-710-07	IC NJM2234M	(KV-13M30/13M31)
IC216	8-759-710-86	IC NJM2233BM	(KV-13M20/14R20/14RD1/14PM1)
IC217	8-759-710-07	IC NJM2234M	(KV-13M30/13M31)
IC301	8-752-070-52	IC CXA1870S	
IC402	8-759-365-39	IC TDA7267	
IC501	8-759-801-98	IC LA7830	
IC502	8-759-100-96	IC uPC4558G2	
IC601	8-759-198-33	IC uPC1093J-1	
IC693	8-759-371-21	IC MM1319AFBE	
<JACK>			
J201	1-580-441-31	JACK, PIN 2P	
J202	1-580-441-41	JACK, PIN 2P	(KV-13M30/13M31)
J400	1-568-267-21	JACK	
<CHIP CONDUCTOR>			
JR002	1-216-295-91	CONDUCTOR, CHIP	(2012)
JR007	1-216-295-91	CONDUCTOR, CHIP	(2012)
JR290	1-216-295-91	CONDUCTOR, CHIP	(2012)
<COIL>			
L001	1-410-470-11	INDUCTOR 10UH	

REF.NO.	PART NO.	DESCRIPTION	REMARK
L002	1-408-421-00	INDUCTOR 100UH	
L003	1-408-421-00	INDUCTOR 100UH	
L202	1-410-470-11	INDUCTOR 10UH	
L316	1-410-671-31	INDUCTOR 47UH	
L501	1-412-553-11	INDUCTOR 3.3MMH	
L502	1-410-669-31	INDUCTOR 33UH	
L503	1-412-531-31	INDUCTOR 33UH	
L551	1-412-533-21	INDUCTOR 47UH	
<TRANSISTOR>			
Q205	8-729-422-27	TRANSISTOR 2SD601A-Q	
Q301	8-729-216-22	TRANSISTOR 2SA1162-G	
Q305	8-729-216-22	TRANSISTOR 2SA1162-G	
Q406	8-729-422-27	TRANSISTOR 2SD601A-Q	
Q504	8-729-105-08	TRANSISTOR 2SA1330-06	
Q550	8-729-140-96	TRANSISTOR 2SD774-34	
Q551	8-729-810-49	TRANSISTOR 2SD1877S-SONY-CA	
Q601	8-729-422-27	TRANSISTOR 2SD601A-Q	
Q602	8-729-035-37	TRANSISTOR 2SC5271-ROYG-F	
Q603	8-729-035-37	TRANSISTOR 2SC5271-ROYG-F	
Q606	8-729-423-99	TRANSISTOR 2SD2137-OP	
Q607	8-729-111-55	TRANSISTOR 2SD1312-K	
Q612	8-729-422-27	TRANSISTOR 2SD601A-Q	
Q613	8-729-422-27	TRANSISTOR 2SD601A-Q	
Q614	8-729-422-27	TRANSISTOR 2SD601A-Q	
Q615	8-729-422-27	TRANSISTOR 2SD601A-Q	
<RESISTOR>			
R001	1-216-065-00	METAL GLAZE 4 7K	5% 1/10W
R002	1-216-073-00	METAL GLAZE 10K	5% 1/10W
R003	1-216-033-00	METAL GLAZE 220	5% 1/10W
R005	1-249-429-11	CARBON 10K	5% 1/4W
R007	1-249-421-11	CARBON 2.2K	5% 1/4W
R008	1-216-033-00	METAL GLAZE 220	5% 1/10W
R009	1-216-033-00	METAL GLAZE 220	5% 1/10W
R012	1-247-815-91	CARBON 220	5% 1/4W
R013	1-216-081-00	METAL GLAZE 22K	5% 1/10W
R014	1-216-033-00	METAL GLAZE 220	5% 1/10W
R015	1-216-033-00	METAL GLAZE 220	5% 1/10W
R016	1-216-041-00	METAL GLAZE 470	5% 1/10W
R017	1-216-113-00	METAL GLAZE 470K	5% 1/10W
R018	1-216-049-91	METAL GLAZE 1K	5% 1/10W
R019	1-249-425-11	CARBON 4.7K	5% 1/4W
R020	1-216-069-00	METAL GLAZE 6 8K	5% 1/10W
R021	1-216-045-00	METAL GLAZE 680	5% 1/10W
R022	1-216-047-91	METAL GLAZE 820	5% 1/10W
R023	1-216-057-00	METAL GLAZE 2 2K	5% 1/10W
R025	1-216-033-00	METAL GLAZE 220	5% 1/10W
R026	1-216-033-00	METAL GLAZE 220	5% 1/10W
R027	1-216-033-00	METAL GLAZE 220	5% 1/10W
R028	1-216-041-00	METAL GLAZE 470	5% 1/10W
R029	1-249-431-11	CARBON 15K	5% 1/4W
R030	1-249-429-11	CARBON 10K	5% 1/4W
R031	1-216-045-00	METAL GLAZE 680	5% 1/10W

The components identified by shading and mark Δ are critical for safety
 Replace only with part number specified



REF.NO.	PART NO.	DESCRIPTION	REMARK	REF.NO.	PART NO.	DESCRIPTION	REMARK
R032	1-216-033-00	METAL GLAZE	220 5% 1/10W	R297	1-216-295-91	CONDUCTOR, CHIP	(2012)
R033	1-216-033-00	METAL GLAZE	220 5% 1/10W	R301	1-249-425-11	CARBON	4 7K 5% 1/4W
R038	1-216-049-91	METAL GLAZE	1K 5% 1/10W	R302	1-216-057-00	METAL GLAZE	2 2K 5% 1/10W
R039	1-216-077-00	METAL GLAZE	15K 5% 1/10W	R306	1-249-417-11	CARBON	1K 5% 1/4W
				R307	1-216-295-91	CONDUCTOR, CHIP	(2012)
R042	1-249-425-11	CARBON	4 7K 5% 1/4W	R310	1-216-065-00	METAL GLAZE	4.7K 5% 1/10W
R043	1-249-417-11	CARBON	1K 5% 1/4W	R312	1-216-295-91	CONDUCTOR, CHIP	(2012)
R044	1-247-815-91	CARBON	220 5% 1/4W	R335	1-247-815-91	CARBON	220 5% 1/4W
R045	1-216-065-00	METAL GLAZE	4 7K 5% 1/10W	R336	1-247-815-91	CARBON	220 5% 1/4W
R046	1-247-815-91	CARBON	220 5% 1/4W	R339	1-216-057-00	METAL GLAZE	2 2K 5% 1/10W
R047	1-216-065-00	METAL GLAZE	4.7K 5% 1/10W	R340	1-216-077-00	METAL GLAZE	15K 5% 1/10W
R048	1-216-025-91	METAL GLAZE	100 5% 1/10W	R341	1-216-113-00	METAL GLAZE	470K 5% 1/10W
R049	1-216-089-91	METAL GLAZE	47K 5% 1/10W	R342	1-216-033-00	METAL GLAZE	220 5% 1/10W
R050	1-216-073-00	METAL GLAZE	10K 5% 1/10W	R343	1-247-815-91	CARBON	220 5% 1/4W
R054	1-216-073-00	METAL GLAZE	10K 5% 1/10W	R344	1-247-815-91	CARBON	220 5% 1/4W
R055	1-216-033-00	METAL GLAZE	220 5% 1/10W	R345	1-247-815-91	CARBON	220 5% 1/4W
R056	1-216-065-00	METAL GLAZE	4.7K 5% 1/10W	R346	1-247-815-91	CARBON	220 5% 1/4W
R057	1-216-065-00	METAL GLAZE	4.7K 5% 1/10W	R347	1-216-045-00	METAL GLAZE	680 5% 1/10W
R058	1-216-065-00	METAL GLAZE	4 7K 5% 1/10W	R348	1-247-815-91	CARBON	220 5% 1/4W
R072	1-216-033-00 (KV-13M30/13M31)	METAL GLAZE	220 5% 1/10W	R349	1-247-807-31	CARBON	100 5% 1/4W
R101	1-249-429-11	CARBON	10K 5% 1/4W	R351	1-249-429-11	CARBON	10K 5% 1/4W
R203	1-215-899-11	METAL OXIDE	15K 5% 2W F	R353	1-249-417-11	CARBON	1K 5% 1/4W
R206	1-216-689-11	METAL GLAZE	39K 5% 1/10W	R355	1-216-077-00	METAL GLAZE	15K 5% 1/10W
R207	1-216-083-00	METAL GLAZE	27K 5% 1/10W	R356	1-249-421-11	CARBON	2 2K 5% 1/4W
R208	1-216-065-00	METAL GLAZE	4 7K 5% 1/10W	R357	1-216-073-00	METAL GLAZE	10K 5% 1/10W
R209	1-216-069-00	METAL GLAZE	6 8K 5% 1/10W	R360	1-216-071-00	METAL GLAZE	8.2K 5% 1/10W
R210	1-216-033-00	METAL GLAZE	220 5% 1/10W	R361	1-216-033-00	METAL GLAZE	220 5% 1/10W
R211	1-216-049-91	METAL GLAZE	1 0K 5% 1/10W	R362	1-216-041-00	METAL GLAZE	470 5% 1/10W
R212	1-249-425-11	CARBON	4 7K 5% 1/4W	R363	1-216-105-91	METAL GLAZE	220K 5% 1/10W
R222	1-216-073-00 (KV-13M30/13M31)	METAL GLAZE	10K 5% 1/10W	R365	1-247-419-11	CARBON	1.5K 5% 1/4W
R223	1-247-807-31	CARBON	100 5% 1/4W	R372	1-216-057-00	METAL GLAZE	2 2K 5% 1/10W
R225	1-216-295-91 (KV-13M30/13M31)	CONDUCTOR, CHIP	(2012)	R430	1-216-089-91	METAL GLAZE	47K 5% 1/10W
R226	1-216-295-91 (KV-13M30/13M31)	CONDUCTOR, CHIP	(2012)	R432	1-216-097-91	METAL GLAZE	100K 5% 1/10W
R231	1-216-113-00	METAL GLAZE	470K 5% 1/10W	R439	1-216-065-00	METAL GLAZE	4 7K 5% 1/10W
R232	1-216-022-00	METAL GLAZE	75 5% 1/10W	R450	1-216-049-91	METAL GLAZE	1 0K 5% 1/10W
R243	1-216-295-91 (KV-13M30/13M31)	CONDUCTOR, CHIP	(2012)	R460	1-216-061-00	METAL GLAZE	3 3K 5% 1/10W
R263	1-216-022-00 (KV-13M30/13M31)	METAL GLAZE	75 5% 1/10W	R480	1-216-057-00	METAL GLAZE	2 2K 5% 1/10W
R264	1-216-113-00 (KV-13M30/13M31)	METAL GLAZE	470K 5% 1/10W	R490	1-249-417-11	CARBON	1K 5% 1/4W
R284	1-216-041-00	METAL GLAZE	470 5% 1/10W	R491	1-249-411-11	CARBON	330 5% 1/4W
R285	1-216-041-00	METAL GLAZE	470 5% 1/10W	R492	1-249-411-11	CARBON	330 5% 1/4W
R290	1-247-807-31 (KV-13M30/13M31)	METAL GLAZE	100 5% 1/4W	R495	1-216-349-00	METAL OXIDE	1 5% 1W F
R291	1-216-295-91	CONDUCTOR, CHIP	(2012)	R501	1-216-073-00	METAL GLAZE	10K 5% 1/10W
R292	1-216-295-91 (KV-13M20/14RD1/14PM1)	CONDUCTOR, CHIP	(2012)	R505	1-216-349-00	METAL OXIDE	1 5% 1W F
				R506	1-216-453-00	METAL OXIDE	270 5% 2W F
				R507	1-247-891-00	CARBON	330K 5% 1/4W
				R508	1-249-417-11	CARBON	1K 5% 1/4W
				R509	1-216-101-00	METAL GLAZE	150K 5% 1/10W
				R510	1-249-420-11	CARBON	1.8K 5% 1/4W
				R511	1-249-429-11	CARBON	10K 5% 1/4W
				R512	1-208-806-11	METAL GLAZE	10K 0 50% 1/10W
				R513	1-208-773-11	METAL GLAZE	430 0 50% 1/10W
				R515	1-208-806-11	METAL GLAZE	10K 0 50% 1/10W
				R518	1-215-429-00	METAL	2 2K 1% 1/4W
				R519	1-215-902-11	METAL OXIDE	47K 5% 2W F



The components identified by shading and mark Δ are critical for safety. Replace only with part number specified.

REF.NO.	PART NO.	DESCRIPTION	REMARK
R520	1-208-777-11	METAL GLAZE	620 0 50%1/10W
R523	1-215-459-00	METAL	100K 1% 1/4W
R523	1-215-459-00	METAL GLAZE	1/10W
R527	1-208-806-11	METAL GLAZE	10K 0 50%1/10W
R531	1-216-359-00	METAL OXIDE	6 8 5% 1W F
R532	1-215-457-00	METAL	33K 1% 1/4W
R533	1-216-359-00	METAL OXIDE	6.8 5% 1W F
R534	1-215-462-00	FILM	51K 1% 1/4W
R536	1-215-437-00	METAL	4.7K 1% 1/4W
R538	1-215-863-11	METAL OXIDE	100 5% 1W F
R539	1-215-870-11	METAL OXIDE	1.5k 5% 1W F
R540	1-249-441-11	CARBON	100K 5% 1/4W
R542	1-216-093-00	METAL GLAZE	68K 5% 1/10W
R543	1-208-842-11	METAL GLAZE	330K 0 50%1/10W
R544	1-208-785-11	METAL GLAZE	1 3K 0.50%1/10W
R545	1-249-441-11	CARBON	100K 5% 1/4W
R547	1-249-429-11	CARBON	10K 5% 1/4W
R548	1-216-113-00	METAL GLAZE	470K 5% 1/10W
R549	1-216-369-00	METAL OXIDE	1 5% 2W F
R550	1-216-295-91	CONDUCTOR, CHIP	(2012)
R554	1-216-057-00	METAL GLAZE	2.2K 5% 1/10W
R555	1-216-462-00	METAL OXIDE	8 2K 5% 2W F
R559	1-216-089-91	METAL GLAZE	47K 5% 1/10W
R560	1-216-097-91	METAL GLAZE	100K 5% 1/10W
R562	1-215-882-00	METAL OXIDE	22 5% 2W F
R568	1-215-865-11	METAL OXIDE	220 5% 1W F
R590	1-216-295-91	CONDUCTOR, CHIP	(2012)
R601	1-219-513-11	RES(SURGE RES)	4.7M 5% 1/2W
R602	1-216-073-00	METAL GLAZE	10K 5% 1/10W
R603	1-205-998-11	CEMENT	1 5% 10W
R605	1-216-057-00	METAL GLAZE	2.2K 5% 1/10W
R606	1-260-288-11	RES, CARBON	0.47 5% 1/2W
R609	1-216-353-00	METAL OXIDE	2 2 5% 1W F
R610	1-216-353-00	METAL OXIDE	2.2 5% 1W F
R611	1-249-396-11	CARBON	18 5% 1/4W
R612	1-249-396-11	CARBON	18 5% 1/4W
R615	1-216-093-00	METAL GLAZE	68K 5% 1/10W
R616	1-216-057-00	METAL GLAZE	2.2K 5% 1/10W
R617	1-208-790-11	METAL GLAZE	2.2K 0.50%1/10W
R618	1-215-463-00	METAL	100K 1% 1/4W
R619	1-216-001-00	METAL GLAZE	10 5% 1/10W
R625	1-216-377-11	METAL OXIDE	4.7 5% 2W F
R628	1-249-415-11	CARBON	680 5% 1/4W
R629	1-208-806-11	METAL GLAZE	10K 0.50%1/10W
R630	1-208-826-11	METAL GLAZE	68K 0.50%1/10W
R635	1-212-857-00	RES, FUSE	10 5% 1/4W
R641	1-247-889-00	CARBON	270K 5% 1/4W
R643	1-247-889-00	CARBON	270K 5% 1/4W
R645	1-247-893-11	CARBON	390K 5% 1/4W
R651	1-216-089-91	METAL GLAZE	47K 5% 1/10W
R652	1-216-073-00	METAL GLAZE	10K 5% 1/10W
R653	1-216-065-00	METAL GLAZE	4.7K 5% 1/10W
R654	1-216-073-00	METAL GLAZE	10K 5% 1/10W
R655	1-216-085-00	METAL GLAZE	33K 5% 1/10W

REF.NO.	PART NO.	DESCRIPTION	REMARK
R656	1-216-089-91	METAL GLAZE	47K 5% 1/10W
R681	1-216-089-91	METAL GLAZE	47K 5% 1/10W
R682	1-216-073-00	METAL GLAZE	10K 5% 1/10W
R683	1-215-924-00	METAL OXIDE	15K 5% 3W F
R684	1-249-429-11	CARBON	10K 5% 1/4W
R690	1-216-355-11	METAL OXIDE	3 3 5% 1W F
R704	1-216-369-00	METAL OXIDE	1 5% 2W F
<RELAY>			
RY601	1-755-145-11	RELAY	
<SWITCH>			
S001	1-692-431-21	SWITCH, TACTILE	
S002	1-692-431-21	SWITCH, TACTILE	
S003	1-692-431-21	SWITCH, TACTILE	
S004	1-692-431-21	SWITCH, TACTILE	
S005	1-692-431-21	SWITCH, TACTILE	
S006	1-692-431-21	SWITCH, TACTILE	
<TRANSFORMER>			
T504	1-453-218-11	TRANSFORMER, FLYBACK	
T551	1-437-195-11	TRANSFORMER, HORIZONTAL DRIVE	
T602	1-423-895-11	TRANSFORMER, LINE FILTER (LFT)	
T603	1-429-483-21	TRANSFORMER, CONVERTER PIT	
T604	1-427-864-11	TRANSFORMER, CONVERTER (PR2)	
<THERMISTOR>			
THP603	1-810-597-11	THERMISTOR, POSITIVE	
<TUNER>			
TU101	8-598-333-00	TUNER BIF-LA402	
<VARISTOR>			
VDR601	1-801-074-41	VARISTOR ERZV10D271	
<CRYSTAL>			
X300	1-577-611-11	OSCILLATOR, CERAMIC	
X303	1-760-190-41	VIBRATOR, CRYSTAL	
* A-1331-519-A MOUNTED PCB, C *****			
<CAPACITOR>			
C701	1-136-601-11	FILM	0.01MF 10% 630V
C706	1-126-965-11	ELECT	22MF 20% 50V
C712	1-163-135-00	CERAMIC CHIP	560pF 5% 50V
C732	1-163-005-11	CERAMIC CHIP	470pF 10% 50V
C752	1-163-005-11	CERAMIC CHIP	470pF 10% 50V
C771	1-102-110-00	CERAMIC	220pF 10% 50V
C772	1-102-110-00	CERAMIC	220pF 10% 50V
C773	1-102-110-00	CERAMIC	220pF 10% 50V

The components identified by shading and mark **▲** are critical for safety. Replace only with part number specified.



REF.NO.	PART NO.	DESCRIPTION	REMARK
<CONNECTOR>			
CN701	1-695-915-11	TAB (CONTACT)	
<DIODE>			
D770	8-719-991-33	DIODE 1SS133T-77	
D771	8-719-991-33	DIODE 1SS133T-77	
D772	8-719-991-33	DIODE 1SS133T-77	
D773	8-719-991-33	DIODE 1SS133T-77	
D777	8-719-109-72	DIODE RD3 9ESB2	
<JACK>			
J701	1-251-182-11	SOCKET CR2	
<COIL>			
L702	1-408-419-00	INDUCTOR 68UH	
<TRANSISTOR>			
Q711	8-729-326-11	TRANSISTOR 2SC2611	
Q731	8-729-326-11	TRANSISTOR 2SC2611	
Q751	8-729-326-11	TRANSISTOR 2SC2611	
Q770	8-729-119-76	TRANSISTOR 2SA1175-HFE	
Q771	8-729-200-17	TRANSISTOR 2SA1091-O	
Q772	8-729-200-17	TRANSISTOR 2SA1091-O	
Q773	8-729-200-17	TRANSISTOR 2SA1091-O	
<RESISTOR>			
R700	1-260-087-11	CARBON 100	5% 1/2W
R702	1-260-131-11	CARBON 470K	5% 1/2W
R703	1-260-123-11	CARBON 100K	5% 1/2W
R707	1-260-131-11	CARBON 470K	5% 1/2W
R708	1-260-135-11	CARBON 1M	5% 1/2W
R710	1-260-099-11	CARBON 1K	5% 1/2W
R712	1-215-924-00	METAL OXIDE 15K	5% 3W F
R716	1-249-412-11	CARBON 390	5% 1/4W
R717	1-216-295-91	CONDUCTOR, CHIP (2012)	
R730	1-260-099-11	CARBON 1K	5% 1/2W
R732	1-215-924-00	METAL OXIDE 15K	5% 3W F
R736	1-249-412-11	CARBON 390	5% 1/4W
R737	1-216-295-91	CONDUCTOR, CHIP (2012)	
R750	1-260-099-11	CARBON 1K	5% 1/2W
R752	1-215-924-00	METAL OXIDE 15K	5% 3W F
R756	1-249-412-11	CARBON 390	5% 1/4W
R757	1-216-295-91	CONDUCTOR, CHIP (2012)	
R770	1-216-089-91	METAL GLAZE 47K	5% 1/10W
R771	1-216-049-91	METAL GLAZE 1K	5% 1/10W
R772	1-216-049-91	METAL GLAZE 1K	5% 1/10W
R773	1-216-049-91	METAL GLAZE 1K	5% 1/10W
R774	1-216-089-91	METAL GLAZE 47K	5% 1/10W
R775	1-216-049-91	METAL GLAZE 1K	5% 1/10W
R776	1-216-033-00	METAL GLAZE 220	5% 1/10W

REF.NO.	PART NO.	DESCRIPTION	REMARK
<VARIABLE RESISTOR>			
RV702	1-230-641-11	RES, ADJ, METAL GLAZE	2 2M
RV703	1-230-641-11	RES, ADJ, METAL GLAZE	2 2M
MISCELLANEOUS *****			
	X-4208-815-0	PERMALLOY ASSY, CONVERGENCE	
▲	1-428-146-21	COIL, DEMAGNETIZATION	
	1-452-032-00	MAGNET, DISC	
	1-452-277-00	MAGNET, BMC	
	1-505-265-11	SPEAKER (9X5CM)	
▲	1-751-087-11	CORD, POWER (WITH CONNECTOR) 10A/125V (KV-13M30/13M20/14R20/14RD1/14PM1)	
▲	1-751-088-11	CORD, POWER (WITH CONNECTOR) 10A/125V (KV-13M31)	
	1-766-374-11	PLUG, F-PIN	
	3-704-372-31	HOLDER, HV CABLE	
	4-046-162-01	EMBLEM (NO 6), SONY	
	4-051-567-01	BUTTON, MULTI (KV-13M30/13M20/14R20/14RD1/14PM1)	
	4-051-567-11	BUTTON, MULTI (KV-13M31)	
	4-051-568-01	FILTER, REMOTE	
	4-051-569-01	DOOR, CONTROL (KV-13M30/13M20/14R20/14RD1/14PM1)	
	4-051-569-11	DOOR, CONTROL (KV-13M31)	
▲	8-453-418-11	DP Y14NDX2 (VTE)	
▲	8-735-562-05	CRT 14NDXM	
ACCESSORIES AND PACKING MATERIALS *****			
	1-417-182-11	CONVERTER (EAC-25)	
	1-501-730-11	ANTENNA, TELESCOPIC (KV-14R20/14RD1/14PM1)	
	1-501-730-41	ANTENNA, TELESCOPIC (KV-13M20/13M30/13M31)	
*	3-701-627-00	BAG, POLYETHYLENE	
	3-810-814-21	MANUAL, INSTRUCTION (KV-13M20/13M30/13M31)	
	3-810-814-41	MANUAL, INSTRUCTION (KV-14R20/14RD1/14PM1)	
*	4-041-253-01	BAG, PROTECTION	
*	4-052-620-01	CUSHION (LOWER) (ASSY)	
*	4-052-621-01	CUSHION (UPPER) (ASSY)	
*	4-052-622-01	CARTON, INDIVIDUAL (KV-13M20/13M30/13M31)	
*	4-052-630-01	CARTON, INDIVIDUAL (KV-14R20/14RD1/14PM1)	
REMOTE COMMANDER *****			
	1-466-966-31	REMOTE COMMANDER (RM-Y116) BLACK (KV-13M20/13M30/14R20/14RD1/14PM1)	
	1-466-966-41	REMOTE COMMANDER (RM-Y116) WHITE (KV-13M31)	
	9-903-826-11	COVER, BATTERY (FOR RM-Y116) BLACK (KV-13M20/13M30/14R20/14RD1/14PM1)	
	9-903-826-21	COVER, BATTERY (FOR RM-Y116) WHITE (KV-13M31)	

